

Solid State Relay G3TB

I/O SSR Used as Interface between Logic Circuitry and Load

- A variety of AC/DC input and output modules classified by color.
- Operation can be monitored easily through an LED indicator.
- Dielectric strength of 4,000 V between input and output terminals.
- Certified by UL and CSA.

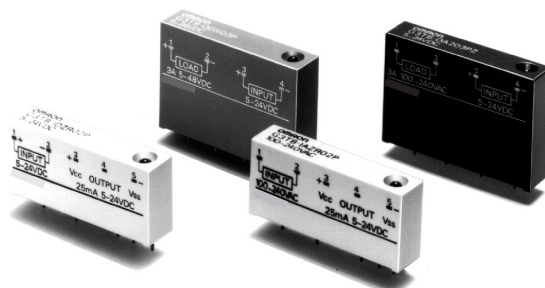

Ordering Information

Input Modules

Isolation	Indicator	Logic level		Rated input voltage	Model
		Supply voltage	Supply current		
Photocoupler	Yes	4 to 32 VDC	25 mA	100 to 240 VAC	G3TB-IAZR02P-US
				4 to 24 VDC	G3TB-IDZR02P-US

Output Modules

Isolation	Zero cross function	Indicator	Rated output voltage (Applicable output load)	Rated input voltage	Model	
Photocoupler	Yes	Yes	3 A at 100 to 240 VAC (3 A at 75 to 264 VAC)	5 to 24 VDC	G3TB-OA203PZ-US	
		No		4 to 24 VDC	G3TB-OA203PZM-US	
	No	Yes		5 to 24 VDC	G3TB-OA203PL-US	
		No		4 to 24 VDC	G3TB-OA203PLM-US	
	---	Yes	No	3 A at 5 to 48 VDC (3 A at 4 to 60 VAC)	5 to 24 VDC	G3TB-ODX03P-US
					4 to 24 VDC	G3TB-ODX03PM-US
		Yes	No	1.5 A at 48 to 200 VDC (1.5 A at 40 to 200 VDC)	5 to 24 VDC	G3TB-OD201P-US
					4 to 24 VDC	G3TB-OD201PM-US

Note: When ordering, specify the rated input voltage.

Specifications

■ Ratings (at an Ambient Temperature of 25°C)

Input Module

Input

Model	Rated voltage	Operating voltage	Input current	Voltage level	
				Must operate voltage	Must release voltage
G3TB-IAZR02P-US	100 to 240 VAC	80 to 264 VDC	5 mA max.	80 VAC max.	10 VAC min.
G3TB-IDZR02P-US	4 to 24 VDC	3 to 32 VDC		3 VDC max.	1 VDC min.

Output

Model	Logic level supply voltage	Output breakdown voltage	Output current
G3TB-IAZR02P-US	4 to 32 VDC	32 VDC max.	25 mA max.
G3TB-IDZR02P-US			

Output Module

Input

Model	Rated voltage	Operating voltage	Input current	Voltage level	
				Must operate voltage	Must release voltage
G3TB-OA203PZ-US	5 to 24 VDC	4 to 32 VDC	5 mA max.	4 VDC max.	1 VDC min.
G3TB-OA203PZM-US	4 to 24 VDC	3 to 32 VDC		3 VDC max.	
G3TB-OA203PL-US	5 to 24 VDC	4 to 32 VDC		4 VDC max.	
G3TB-OA203PLM-US	4 to 24 VDC	3 to 32 VDC		3 VDC max.	
G3TB-ODX03P-US	5 to 24 VDC	4 to 32 VDC		4 VDC max.	
G3TB-ODX03PM-US	4 to 24 VDC	3 to 32 VDC		3 VDC max.	
G3TB-OD201P-US	5 to 24 VDC	4 to 32 VDC		4 VDC max.	
G3TB-OD201PM-US	4 to 24 VDC	3 to 32 VDC		3 VDC max.	

Output

Model	Applicable load			
	Rated load voltage	Load voltage range	Load current (See note.)	Inrush current
G3TB-OA203PZ-US	100 to 240 VAC	75 to 264 VAC	0.05 to 3 A	45 A (60 Hz, 1 cycle)
G3TB-OA203PZM-US				
G3TB-OA203PL-US				
G3TB-OA203PLM-US				
G3TB-ODX03P-US	5 to 48 VDC	4 to 60 VDC	0.01 to 3 A	18 A (10 ms)
G3TB-ODX03PM-US				
G3TB-OD201P-US	48 to 200 VDC	40 to 200 VDC	0.01 to 1.5 A	12 A (10 ms)
G3TB-OD201PM-US				

Note: The minimum current value is measured at 10°C min.

■ Characteristics

Input Module

Item	G3TB-IAZR02P-US	G3TB-IDZR02P-US
Operate time	20 ms max.	1 ms max.
Release time	20 ms max.	1 ms max.
Output ON voltage drop	0.4 V max.	
Leakage current	100 μA max.	
Insulation resistance	100 MΩ min. (at 500 VDC)	
Dielectric strength	4,000 VAC, 50/60 Hz for 1 min between input and output	
Vibration resistance	Malfunction: 10 to 55 Hz, 1.5-mm single amplitude	
Shock resistance	Malfunction: 1,000 m/s ²	
Ambient temperature	Operating: -30°C to 80°C (with no icing or condensation) Storage: -30°C to 100°C (with no icing or condensation)	
Ambient humidity	Operating: 45% to 85%	
Certified standards	UL File No. E41515/CSA File No. LR35535/TÜV R90381 (VDE0806)	
Weight	Approx. 22 g	

Output Module

Item	G3TB-OA203PZ-US	G3TB-OA203PZM-US	G3TB-OA203PL-US	G3TB-OA203PLM-US	G3TB-ODX03P-US	G3TB-ODX03PM-US	G3TB-OD201P-US	G3TB-OD201PM-US
Operate time	1/2 of load power source cycle + 1 ms max.		1 ms max.		0.5 ms max.			
Release time	1/2 of load power source cycle + 1 ms max.				2 ms max.			
Output ON voltage drop	1.6 V max.						2.5 V max.	
Leakage current	5 mA max. (at 200 VAC)				1 mA max.			
Insulation resistance	100 MΩ min. (at 500 VDC)							
Dielectric strength	4,000 VAC, 50/60 Hz for 1 min between input and output							
Vibration resistance	Malfunction: 10 to 55 Hz, 1.5-mm single amplitude							
Shock resistance	Malfunction: 1,000 m/s ²							
Ambient temperature	Operating: -30°C to 80°C (with no icing or condensation) Storage: -30°C to 100°C (with no icing or condensation)							
Ambient humidity	Operating: 45% to 85%							
Certified standards	UL File No. E64562/CSA File No. LR35535/TÜV R90381 (VDE0806)							
Weight	Approx. 32 g							

Engineering Data

Load Current vs. Ambient Temperature Characteristics

G3TB-OA203PZ-US/-OA203PZM-US
 /-OA203PL-US/-OA203PLM-US/
 G3TB-ODX03P-US/-ODX03PM-US

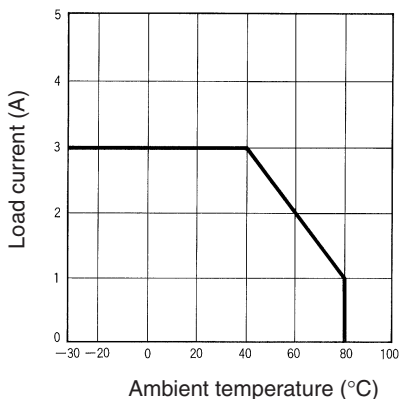

G3TB-OD201P-US/-OD201PM-US

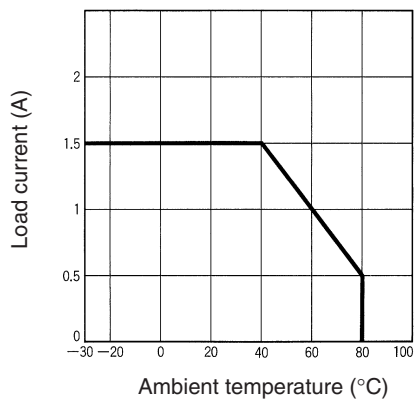

One Cycle Surge Current: Non-repetitive

Non-repetitive (Keep the inrush current to half the rated value if it occurs repetitively.)

G3TB-OA203PZ-US/-OA203PZM-US/
 -OA203PL-US/-OA203PLM-US

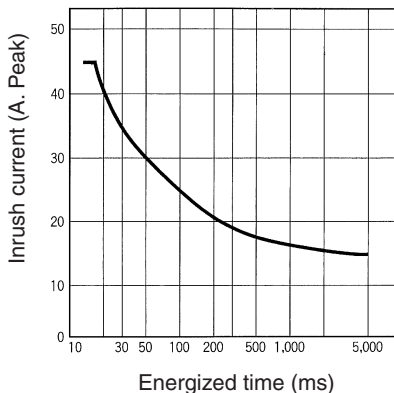

G3TB-ODX03P-US/-ODX03PM-US

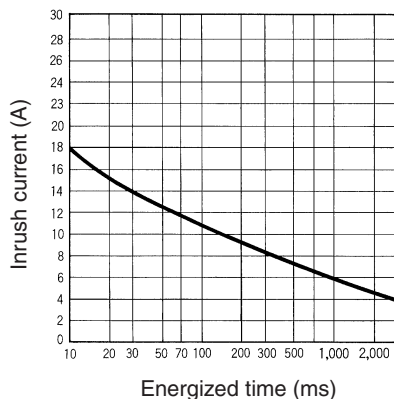

G3TB-OD201P-US/-OD201PM-US

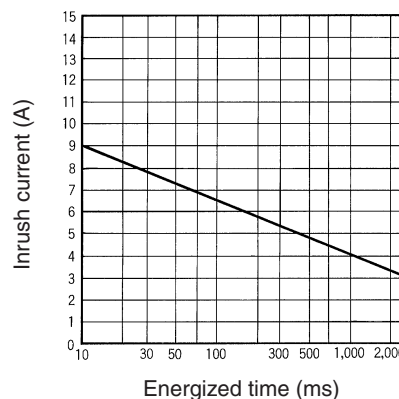

Operation

■ Circuit Configuration

Type	Model	Case color	Indicator	Circuit
AC input	G3TB-IAZR02P-US	Yellow	Yes	
DC input	G3TB-IDZR02P-US	White	Yes	
AC output	G3TB-OA203PZ-US G3TB-OA203PL-US	Black	Yes	
	G3TB-OA203PZM-US G3TB-OA203PLM-US		No	
DC output	G3TB-ODX03P-US G3TB-OD201P-US	Red	Yes	
	G3TB-ODX03PM-US G3TB-OD201PM-US		No	

Example of Logic Output Circuit

Example 1. G3TB-I

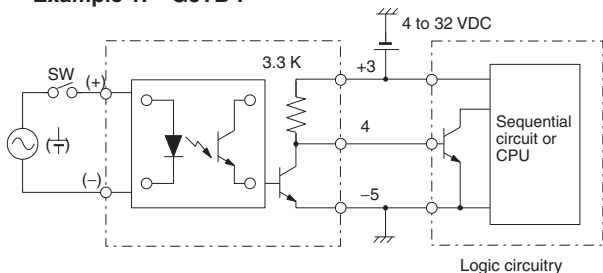

Example 2. G3TB-I

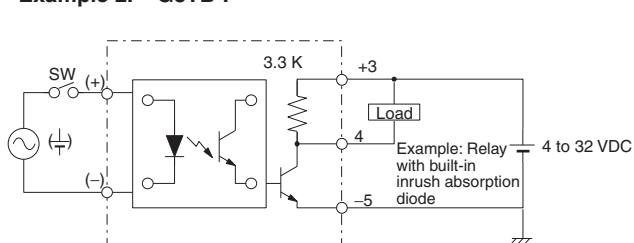

Note: AC- and DC-input versions are available.

Dimensions

Note: All units are in millimeters unless otherwise indicated.

Input SSR G3TB-I

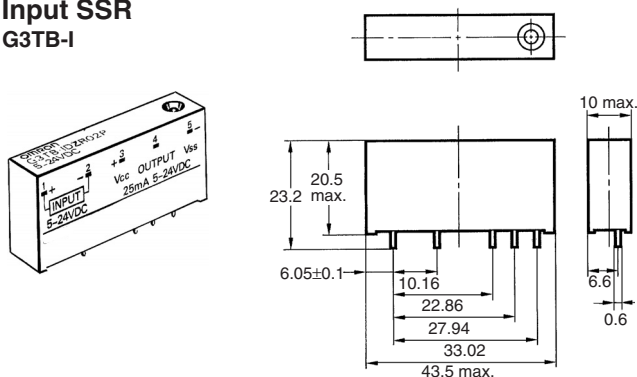

PCB Dimensions (Bottom View)

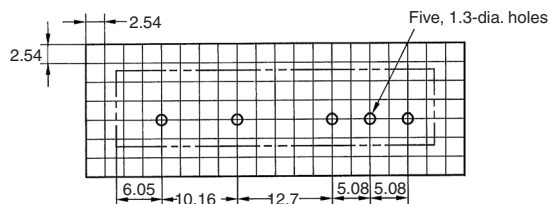

Terminal Arrangement (Bottom View)

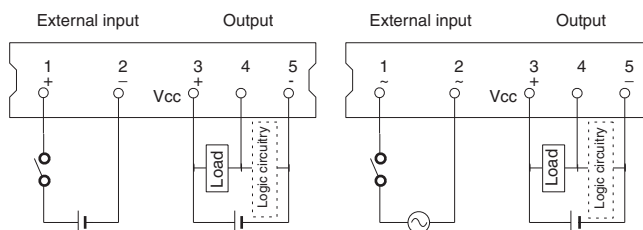

Output SSR
G3TB-O

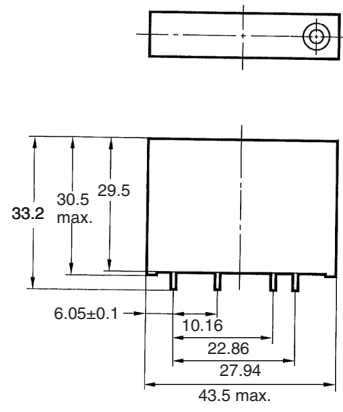
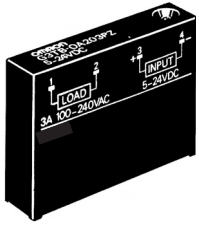

PCB Dimensions
(Bottom View)

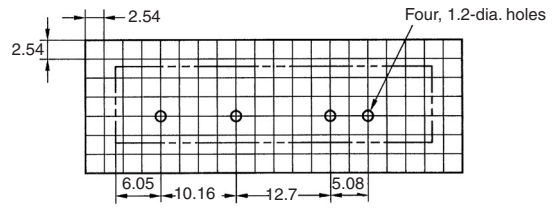

Terminal Arrangement
(Bottom View)

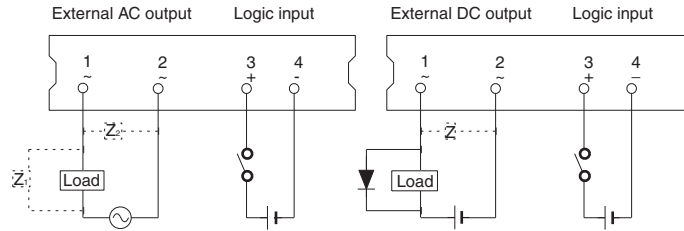

Note: Z₁, Z₂, and Z refer to overvoltage absorption elements that you should connect.

Safety Precautions

■ Precautions for Correct Use

Please observe the following precautions to prevent failure to operate, malfunction, or undesirable effect on product performance.

G3TB

I/O classification by the color is as follows:

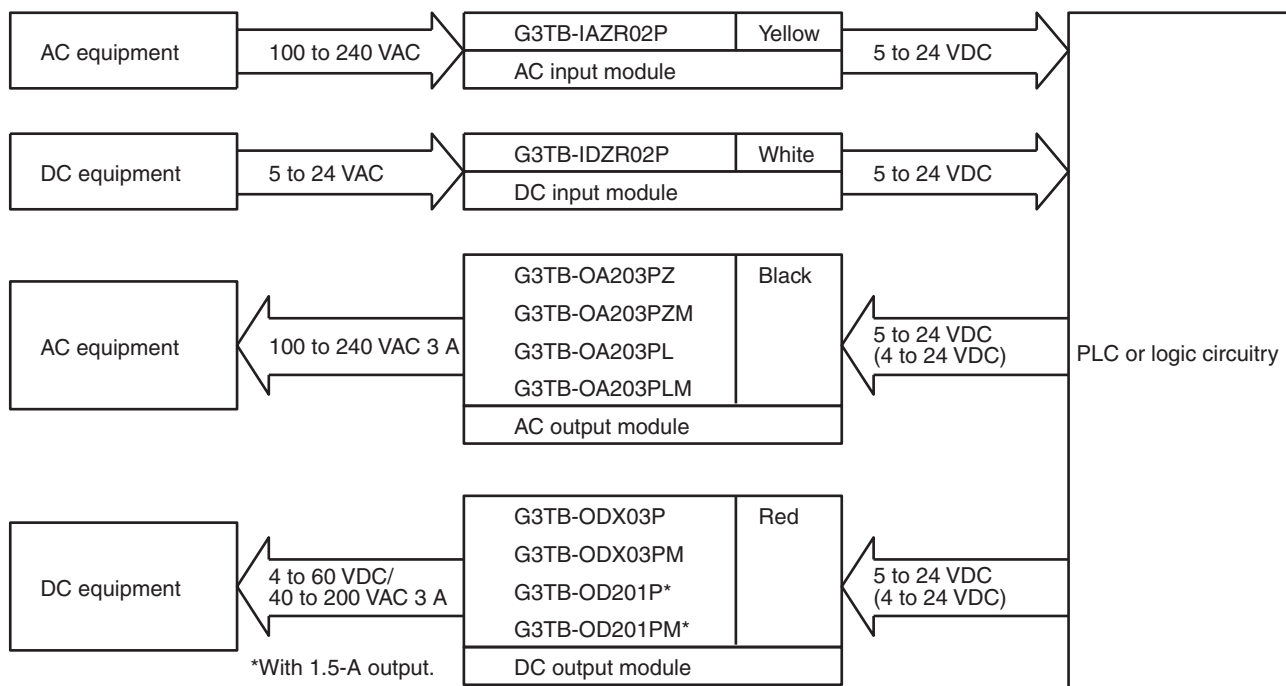

When mounting more than one output module, make a distance of 5 mm minimum between adjacent SSRs. Up to 16-point, 3-A load switching is possible

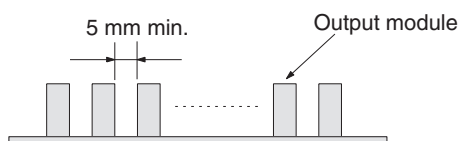

Connection

With the SSR for DC switching, the load can be connected to either positive or negative output terminal of the SSR.

Protective Component

Since the SSR does not incorporate an overvoltage absorption component, be sure to connect an overvoltage absorption component when using the SSR under an inductive load.

All sales are subject to Omron Electronic Components LLC standard terms and conditions of sale, which can be found at http://www.components.omron.com/components/web/webfiles.nsf/sales_terms.html

ALL DIMENSIONS SHOWN ARE IN MILLIMETERS.
To convert millimeters into inches, multiply by 0.03937. To convert grams into ounces, multiply by 0.03527.

OMRON[®]

**OMRON ELECTRONIC
COMPONENTS LLC**

55 E. Commerce Drive, Suite B
Schaumburg, IL 60173

847-882-2288

OMRON ON-LINE

Global - <http://www.omron.com>

USA - <http://www.components.omron.com>

Cat. No. X301-E-1b

09/11

Specifications subject to change without notice

Printed in USA

О компании

ООО "ТрейдЭлектроникс" - это оперативные поставки широкого спектра электронных компонентов отечественного и импортного производства напрямую от производителей и с крупнейших мировых складов. Реализуемая нашей компанией продукция насчитывает более полумиллиона наименований.

Благодаря этому наша компания предлагает к поставке практически не ограниченный ассортимент компонентов как оптовыми, мелкооптовыми партиями, так и в розницу.

Наличие собственной эффективной системы логистики обеспечивает надежную поставку продукции по конкурентным ценам в точно указанные сроки.

Срок поставки со стоков в **Европе и Америке – от 3 до 14 дней.**

Срок поставки из **Азии – от 10 дней.**

Благодаря развитой сети поставщиков, помогаем в поиске и приобретении экзотичных или снятых с производства компонентов.

Предоставляем спец цены на элементы для создания инженерных сэмплов.

Упорный труд, качественный результат дают нам право быть уверенными в себе и надежными для наших клиентов.

Наша компания это:

- Гарантия качества поставляемой продукции
- Широкий ассортимент
- Минимальные сроки поставок
- Техническая поддержка
- Подбор комплектации
- Индивидуальный подход
- Гибкое ценообразование

Наша организация особенно сильна в поставках модулей, микросхем, пассивных компонентов, ксайленсах (XC), EPF, EPM и силовой электроники.

Большой выбор предлагаемой продукции, различные виды оплаты и доставки, позволят Вам сэкономить время и получить максимум выгоды от сотрудничества с нами!

Перечень производителей, продукцию которых мы поставляем на российский рынок



С удовольствием будем прорабатывать для Вас поставки всех необходимых компонентов по текущим запросам для скорейшего выявления групп элементов, по которым сотрудничество именно с нашей компанией будет для Вас максимально выгодным!

С уважением,

Менеджер отдела продаж ООО

«Трейд Электроникс»

Шишлаков Евгений

8 (495)668-30-28 доб 169

manager28@tradeelectronics.ru

<http://www.tradeelectronics.ru/>