



FEATURES

- 40 WATTS MAXIMUM OUTPUT POWER
- OUTPUT CURRENT UP TO 8A
- STANDARD 2.0 X 2.0 X 0.4 INCH PACKAGE
- HIGH EFFICIENCY UP TO 90%
- 2:1 WIDE INPUT VOLTAGE RANGE
- SIX-SIDED CONTINUOUS SHIELD
- FIXED SWITCHING FREQUENCY
- OFFER SINGLE, DUAL, DUAL POSITIVE (TOTAL OUTPUT CURRENT 8A) AND TRIPLE OUTPUT
- CE MARK MEETS 2006/95/EC, 93/68/EEC AND 2004/108/EC
- UL60950-1, EN60950-1 AND IEC60950-1 LICENSED
- ISO9001 CERTIFIED MANUFACTURING FACILITIES
- COMPLIANT TO RoHS EU DIRECTIVE 2002/95/EC

APPLICATIONS

Wireless Network
Telecom/Datacom
Industry Control System
Measurement Equipment
Semiconductor Equipment

DESCRIPTION

The FEC40 series offer 40 watts of output power from a 2 x 2 x 0.4 inch package. The FEC40 series with 2:1 wide input voltage of 9-18VDC, 18-36VDC and 36-75VDC and features 1600VDC of isolation, short-circuit and over-voltage protection.

TECHNICAL SPECIFICATION

All specifications are typical at nominal input, full load and 25°C otherwise noted

OUTPUT SPECIFICATIONS		
Output power		40 Watts, max.
Voltage accuracy FL and nominal Vin	Single / Dual	± 1%
	Triple Main	± 1%
	Auxiliary	± 5%
Minimum load (Note 6)		See Table
Voltage adjustability (Note 7)	Single and Dual output only (not including Dual Positive and triple)	± 10%
Line regulation LL to HL at Full Load	Single/Dual	± 0.5%
	Triple(main)	± 1%
	Triple(auxiliary)	± 5%
Load regulation (Note 8) Min. Load to Full Load	Single	± 0.5%
	Dual	± 1%
	Triple Main	± 2%
	Auxiliary	± 5%
Load cross regulation (Note 9)	Triple(main) Dual/Triple(auxiliary)	± 1% ± 5%
Ripple and noise (Note 10)	20MHz bandwidth (Measured with a 0.1µF/50V MLCC)	See table
Temperature coefficient		±0.02% / °C, max.
Transient response recovery time	25% load step change	250µs
Over voltage protection Zener diode clamp	1.5V output	3.9VDC
	1.8V output	3.9VDC
	2.5V output	3.9VDC
	3.3V output	3.9VDC
	5V output	6.2VDC
	12V output	15VDC
	15V output	18VDC
Over load protection	% of FL at nominal input	150%, max.
Short circuit protection		Hiccup, automatic recovery
GENERAL SPECIFICATIONS		
Efficiency		See table
Isolation voltage	Input to Output	1600VDC, min.
	Input(Output) to Case	1600VDC, min.
Isolation resistance		10 ⁹ ohms, min.
Isolation capacitance		1000pF, max.
Switching frequency (Note 11)		300KHz, typ.
Approvals and standard		IEC60950-1, UL60950-1, EN60950-1
Case material		Nickel-coated copper
Base material		FR4 PCB
Potting material		Epoxy (UL94-V0)
Dimensions		2.00 X 2.00 X 0.40 Inch (50.8 X 50.8 X 10.2 mm)
Weight		60g (2.11oz)
MTBF (Note 1)	BELLCORE TR-NWT-000332	1.398 x 10 ⁶ hrs
	MIL-HDBK-217F	3.585 x 10 ⁵ hrs

INPUT SPECIFICATIONS		
Input voltage range	12V nominal input	9 – 18VDC
	24V nominal input	18 – 36VDC
	48V nominal input	36 – 75VDC
Input filter		L-C type
Input surge voltage 100mS max	12V input	36VDC
	24V input	50VDC
	48V input	100VDC
Input reflected ripple current	Nominal Vin and full load	40mA _{p-p}
Start up time	Nominal Vin and constant resistive load	25mS, typ.
	Powe up Remote ON/OFF	25mS, typ.
Start-up voltage	12V input	9VDC
	24V input	17.8VDC
	48V input	36VDC
Shutdown voltage	12V input	8VDC
	24V input	16VDC
	48V input	34VDC
Remote ON/OFF (Note 12) (Positive logic)	DC-DC ON DC-DC OFF	Open or 3.5V < Vr < 12V Short or 0V < Vr < 1.2V
Input current of remote control pin	Nominal Vin	-0.5mA~+0.5mA
Remote off input current	Nominal Vin	2.5mA

ENVIRONMENTAL SPECIFICATIONS		
Operating ambient temperature		-40°C ~ +85°C (with derating)
Maximum case temperature		+100°C
Storage temperature range		-55°C ~ +105°C
Over temperature protection		115°C, typ
Thermal impedance (Note 13)	Nature convection	9.2°C/Watt
	Heat-sink with 20LFM	7.6°C/Watt
	Heat-sink with 500LFM	2.8°C/Watt
Thermal shock		MIL-STD-810F
Vibration		MIL-STD-810F
Relative humidity		5% to 95% RH

EMC CHARACTERISTICS		
EM I (Note 14)	EN55022	Class A
ESD	EN61000-4-2	Air ± 8KV
		Contact ± 6KV
Radiated immunity	EN61000-4-3	10 V/m Perf. Criteria A
Fast transient (Note 15)	EN61000-4-4	± 2KV Perf. Criteria B
Surge (Note 15)	EN61000-4-5	± 1KV Perf. Criteria B
Conducted immunity	EN61000-4-6	10 Vr.m.s Perf. Criteria A





Model Number	Input Range	Output Voltage	Output Current		Output (4) Ripple & Noise	Input Current		Eff (4) (%)	Capacitor(5) Load max
			Min. load	Full load		No load (3)	Full load (2)		
FEC40-12S1P5	9 – 18 VDC	1.5 VDC	0mA	8000mA	50mVp-p	110mA	1250mA	84	45000µF
FEC40-12S1P8	9 – 18 VDC	1.8 VDC	0mA	8000mA	50mVp-p	110mA	1538mA	82	37700µF
FEC40-12S2P5	9 – 18 VDC	2.5 VDC	0mA	8000mA	50mVp-p	110mA	2083mA	84	27000µF
FEC40-12S3P3	9 – 18 VDC	3.3 VDC	0mA	8000mA	50mVp-p	175mA	2683mA	86	21000µF
FEC40-12S05	9 – 18 VDC	5 VDC	0mA	8000mA	50mVp-p	225mA	4065mA	86	13600µF
FEC40-12S12	9 – 18 VDC	12 VDC	0mA	3333mA	75mVp-p	255mA	4065mA	86	2360µF
FEC40-12S15	9 – 18 VDC	15 VDC	0mA	2666mA	75mVp-p	310mA	4015mA	87	1510µF
FEC40-12D12	9 – 18 VDC	± 12 VDC	± 144mA	± 1800mA	120mVp-p	30mA	4444mA	85	± 1200µF
FEC40-12D15	9 – 18 VDC	± 15 VDC	± 112mA	± 1400mA	150mVp-p	35mA	4321mA	85	± 750µF
FEC40-12D3305	9 – 18 VDC	3.3 / 5 VDC	0mA	4A / 4A (total 8A) (16)	100mVp-p	325mA	3416mA	85	11000 / 6800µF
FEC40-12T3312	9 – 18 VDC	3.3 / ±12 VDC	600mA / ±40mA	6000mA / ±400mA	50 / 75mVp-p	215mA	3063mA	84	13000 / ±330µF
FEC40-12T3315	9 – 18 VDC	3.3 / ±15 VDC	600mA / ±30mA	6000mA / ±300mA	50 / 75mVp-p	230mA	3000mA	84	13000 / ±110µF
FEC40-12T0512	9 – 18 VDC	5 / ±12 VDC	600mA / ±40mA	6000mA / ±400mA	50 / 75mVp-p	280mA	4024mA	86	6800 / ±330µF
FEC40-12T0515	9 – 18 VDC	5 / ±15 VDC	600mA / ±30mA	6000mA / ±300mA	50 / 75mVp-p	255mA	3963mA	86	6800 / ±110µF
FEC40-24S1P5	18 – 36 VDC	1.5 VDC	0mA	8000mA	50mVp-p	40mA	649mA	81	45000µF
FEC40-24S1P8	18 – 36 VDC	1.8 VDC	0mA	8000mA	50mVp-p	40mA	759mA	83	37700µF
FEC40-24S2P5	18 – 36 VDC	2.5 VDC	0mA	8000mA	50mVp-p	40mA	1016mA	86	27000µF
FEC40-24S3P3	18 – 36 VDC	3.3 VDC	0mA	8000mA	50mVp-p	60mA	1325mA	87	21000µF
FEC40-24S05	18 – 36 VDC	5 VDC	0mA	8000mA	50mVp-p	80mA	1961mA	89	13600µF
FEC40-24S12	18 – 36 VDC	12 VDC	0mA	3333mA	75mVp-p	70mA	2048mA	88	2360µF
FEC40-24S15	18 – 36 VDC	15 VDC	0mA	2666mA	75mVp-p	85mA	1985mA	89	1510µF
FEC40-24D12	18 – 36 VDC	± 12 VDC	± 144mA	± 1800mA	120mVp-p	20mA	2169mA	87	± 1200µF
FEC40-24D15	18 – 36 VDC	± 15 VDC	± 112mA	± 1400mA	150mVp-p	20mA	2108mA	87	± 750µF
FEC40-24D3305	18 – 36 VDC	3.3 / 5 VDC	0mA	4A / 4A (total 8A) (16)	100mVp-p	80mA	1689mA	86	11000 / 6800µF
FEC40-24T3312	18 – 36 VDC	3.3 / ±12 VDC	600mA / ±40mA	6000mA / ±400mA	50 / 75mVp-p	65mA	1512mA	85	13000 / ±330µF
FEC40-24T3315	18 – 36 VDC	3.3 / ±15 VDC	600mA / ±30mA	6000mA / ±300mA	50 / 75mVp-p	65mA	1481mA	85	13000 / ±110µF
FEC40-24T0512	18 – 36 VDC	5 / ±12 VDC	600mA / ±40mA	6000mA / ±400mA	50 / 75mVp-p	60mA	1989mA	87	6800 / ±330µF
FEC40-24T0515	18 – 36 VDC	5 / ±15 VDC	600mA / ±30mA	6000mA / ±300mA	50 / 75mVp-p	75mA	1958mA	87	6800 / ±110µF
FEC40-48S1P5	36 – 75 VDC	1.5 VDC	0mA	8000mA	50mVp-p	25mA	321mA	82	45000µF
FEC40-48S1P8	36 – 75 VDC	1.8 VDC	0mA	8000mA	50mVp-p	25mA	375mA	84	37700µF
FEC40-48S2P5	36 – 75 VDC	2.5 VDC	0mA	8000mA	50mVp-p	25mA	508mA	86	27000µF
FEC40-48S3P3	36 – 75 VDC	3.3 VDC	0mA	8000mA	50mVp-p	35mA	655mA	88	21000µF
FEC40-48S05	36 – 75 VDC	5 VDC	0mA	8000mA	50mVp-p	40mA	969mA	90	13600µF
FEC40-48S12	36 – 75 VDC	12 VDC	0mA	3333mA	75mVp-p	50mA	1000mA	89	2360µF
FEC40-48S15	36 – 75 VDC	15 VDC	0mA	2666mA	75mVp-p	50mA	992mA	89	1510µF
FEC40-48D12	36 – 75 VDC	± 12 VDC	± 144mA	± 1800mA	120mVp-p	15mA	1084mA	87	± 1200µF
FEC40-48D15	36 – 75 VDC	± 15 VDC	± 112mA	± 1400mA	150mVp-p	15mA	1054mA	87	± 750µF
FEC40-48D3305	36 – 75 VDC	3.3 / 5 VDC	0mA	4A / 4A (total 8A) (16)	100mVp-p	45mA	823mA	88	11000 / 6800µF
FEC40-48T3312	36 – 75 VDC	3.3 / ±12 VDC	600mA / ±40mA	6000mA / ±400mA	50 / 75mVp-p	35mA	747mA	86	13000 / ±330µF
FEC40-48T3315	36 – 75 VDC	3.3 / ±15 VDC	600mA / ±30mA	6000mA / ±300mA	50 / 75mVp-p	35mA	732mA	86	13000 / ±110µF
FEC40-48T0512	36 – 75 VDC	5 / ±12 VDC	600mA / ±40mA	6000mA / ±400mA	50 / 75mVp-p	30mA	982mA	88	6800 / ±330µF
FEC40-48T0515	36 – 75 VDC	5 / ±15 VDC	600mA / ±30mA	6000mA / ±300mA	50 / 75mVp-p	40mA	967mA	88	6800 / ±110µF

Note

- BELLCORE TR-NWT-000332. Case I: 50% Stress, Temperature at 40°C.
MIL-HDBK-217F Notice2 @Ta=25 °C, Full load(Ground, Benign, controlled environment).
- Maximum value at nominal input voltage and full load.
- Typical value at nominal input voltage and no load.
- Typical value at nominal input voltage and full load.
- Test by minimum Vin and constant resistive load.
- The output requires minimum loading on the output to maintain specified regulation. Operation in no-load condition will not damage these devices, however they may not meet all listed specification.
- For the single output: Maximum output deviation is 10% inclusive of remote sense and trim. If remote sense is not being used, the +sense should be connected to its corresponding +OUTPUT and likewise the -sense should be connected to its corresponding -OUTPUT.
- Load regulation for triple output:
Main output(V1):10 to 100% with 10% to 100% balanced on auxiliaries.
Auxiliary outputs(V2 and V3):10% to 100% balanced on all outputs.
- Cross regulation for dual output: asymmetrical load 25% / 100% FL.
Cross regulation for triple output:
Main output 100% load, auxiliary 100%,other auxiliary25% to 100%.
Auxiliary outputs(V2 and V3):main output 100% load, auxiliary 100%, other auxiliary 25% to 100% or main output 25%,auxiliary 25%,other auxiliary 25% to 100%.
- The models of FEC40-XXD3305 are specified with a 1uF ceramic output capacitors.
- Switching frequency for dual output: master (5Vo) 300KHZ slave (3.3Vo) 500KHZ
- The ON/OFF control pin voltage is referenced to -Vin.
- Heat sink is optional and P/N : 7G-0026C-F.
- The FEC40 series can meet EN55022 Class A with parallel an external capacitor to the input pins.
Recommend: 12Vin : 6.8µF/50V 1812 MLCC ; 24Vin : 6.8µF/50V 1812 MLCC . 48Vin : 2.2µF/100V 1812 MLCC.
- An external input filter capacitor is required if the module has to meet EN61000-4-4, EN61000-4-5.
The filter capacitor Power Mate suggest: Nippon chemi-con KY series, 220 µF/100V, ESR 48mΩ.
- Any condition of dual output (3.3V/5V) rated lout current, not to exceed 8A of total output currents. The product safety approval Date: 2008/06/12



40 WATTS DC-DC CONVERTER

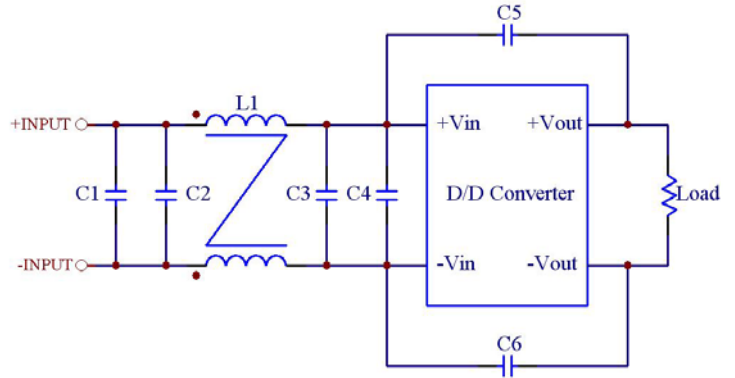
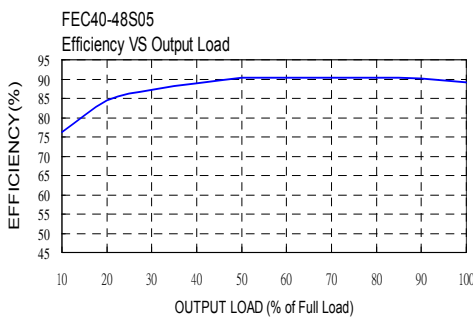
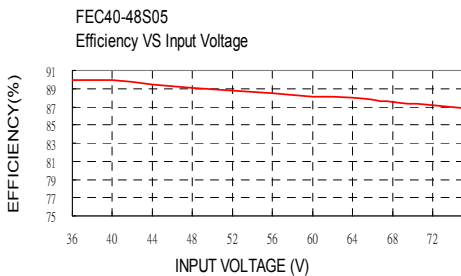
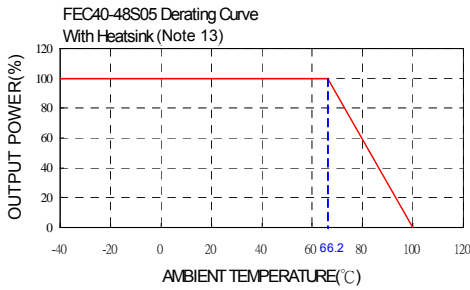
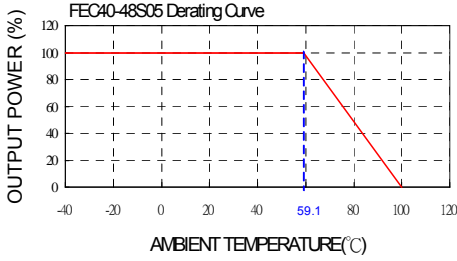

Recommended Filter for EN55022 Class B Compliance

The components used in the above figure, together with the manufacturers' part numbers for these components, are as follows:

	C1	C2	C3	C4	C5 & C6	L1
FEC40-12xxx	4.7μF/50V 1812 MLCC	N/A	4.7μF/50V 1812 MLCC	N/A	1000pF/2KV MLCC	450μH Common Choke PMT-048
FEC40-24xxx	6.8μF/50V 1812 MLCC	N/A	6.8μF/50V 1812 MLCC	N/A	1000pF/2KV MLCC	450μH Common Choke PMT-048
FEC40-48xxx	2.2μF/100V 1812 MLCC	2.2μF/100V 1812 MLCC	2.2μF/100V 1812 MLCC	2.2μF/100V 1812 MLCC	1000pF/2KV MLCC	830μH Common Choke PMT-053

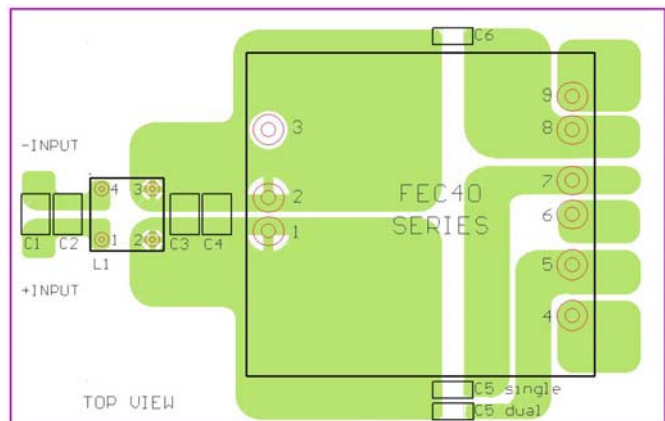

Recommended EN55022 Class B Filter Circuit Layout



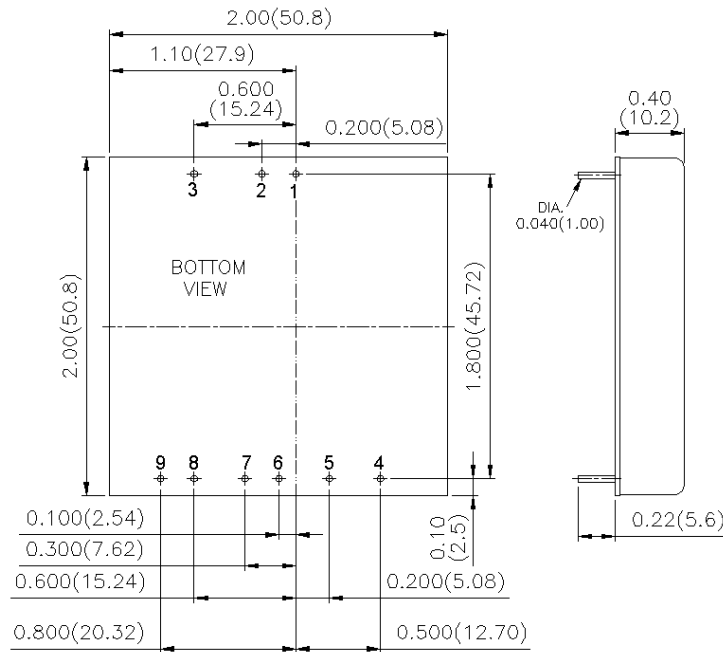

1. All dimensions in Inches (mm)
Tolerance: X.XX±0.02 (X.X±0.5)
X.XXX±0.01 (X.XX±0.25)
2. Pin pitch tolerance ±0.01(0.25)
3. Pin dimension tolerance ±0.004 (0.1)

PIN CONNECTION

PIN	SINGLE	DUAL	DUAL POSITIVE	TRIPLE
1	+INPUT	+INPUT	+INPUT	+INPUT
2	-INPUT	-INPUT	-INPUT	-INPUT
3	CTRL	CTRL	CTRL	CTRL
4	NC	NO PIN	3.3V	+AUX
5	-SENSE (Note 7)	+OUTPUT	COMMON	COMMON
6	+SENSE (Note 7)	COMMON	NC	-AUX
7	+OUTPUT	COMMON	NC	+OUTPUT
8	-OUTPUT	-OUTPUT	5V	COMMON
9	TRIM	TRIM	COMMON	NC

EXTERNAL OUTPUT TRIMMING

Output can be externally trimmed by using the method shown below.
() for dual output trim

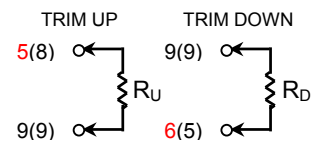

О компании

ООО "ТрейдЭлектроникс" - это оперативные поставки широкого спектра электронных компонентов отечественного и импортного производства напрямую от производителей и с крупнейших мировых складов. Реализуемая нашей компанией продукция насчитывает более полумиллиона наименований.

Благодаря этому наша компания предлагает к поставке практически не ограниченный ассортимент компонентов как оптовыми, мелкооптовыми партиями, так и в розницу.

Наличие собственной эффективной системы логистики обеспечивает надежную поставку продукции по конкурентным ценам в точно указанные сроки.

Срок поставки со стоков в **Европе и Америке – от 3 до 14 дней.**

Срок поставки из **Азии – от 10 дней.**

Благодаря развитой сети поставщиков, помогаем в поиске и приобретении экзотичных или снятых с производства компонентов.

Предоставляем спец цены на элементы для создания инженерных сэмплов.

Упорный труд, качественный результат дают нам право быть уверенными в себе и надежными для наших клиентов.

Наша компания это:

- Гарантия качества поставляемой продукции
- Широкий ассортимент
- Минимальные сроки поставок
- Техническая поддержка
- Подбор комплектации
- Индивидуальный подход
- Гибкое ценообразование

Наша организация особенно сильна в поставках модулей, микросхем, пассивных компонентов, ксайленсах (XC), EPF, EPM и силовой электроники.

Большой выбор предлагаемой продукции, различные виды оплаты и доставки, позволят Вам сэкономить время и получить максимум выгоды от сотрудничества с нами!

Перечень производителей, продукцию которых мы поставляем на российский рынок



С удовольствием будем прорабатывать для Вас поставки всех необходимых компонентов по текущим запросам для скорейшего выявления групп элементов, по которым сотрудничество именно с нашей компанией будет для Вас максимально выгодным!

С уважением,

Менеджер отдела продаж ООО

«Трейд Электроникс»

Шишлаков Евгений

8 (495)668-30-28 доб 169

manager28@tradeelectronics.ru

<http://www.tradeelectronics.ru/>