



**NEC's BROADBAND  
GaAs MMIC DPDT SWITCH UPG2035T5F  
FOR 2.4 GHz AND 5 GHz WLAN**

**FEATURES**

- **OPERATING FREQUENCY:**  
2.4 to 2.5 GHz and 4.9 to 6.0 GHz (specified)  
2.0 to 6.0 GHz Broadband Operation (unspecified)
- **LOW INSERTION LOSS:**  
0.8 dB TYP. @ 2.4 to 2.5 GHz  
1.2 dB TYP. @ 4.9 to 6.0 GHz
- **POWER HANDLING:**  
 $P_{in (1\text{ dB})} = +31\text{ dBm TYP. @ 2.4 to 2.5 GHz}$   
 $+30\text{ dBm TYP. @ 4.9 to 6.0 GHz}$
- **CONTROL VOLTAGE:**  
+3.0 V / 0 V (Dual control)
- **HIGH ISOLATION:**  
INPUT to OUTPUT = 34 dB TYP. @ 2.4 to 2.5 GHz  
INPUT to OUTPUT = 33 dB TYP. @ 4.9 to 6.0 GHz  
TX to RX, ANT1 to ANT2 = 24 dB TYP. @ 2.4 to 2.5 GHz  
TX to RX, ANT1 to ANT2 = 22 dB TYP. @ 4.9 to 6.0 GHz
- **INPUT/OUTPUT RETURN LOSS:**  
15 dB TYP.
- **SWITCHING SPEED:**  
50 ns @  $t_{RISE}/t_{FALL}$  (10/90% RF)
- **12-PIN PLASTIC QFN PACKAGE:**  
(3.0 × 3.0 × 0.75 mm)
- **Pb FREE**

**DESCRIPTION**

NEC's UPG2035T5F is a GaAs MMIC DPDT switch for 2.4 GHz and 5 GHz dualband Wireless LAN.

The UPG2035T5F features low insertion loss, high isolation, and dualband operation.

**APPLICATIONS**

- **802.11a+b/g WIRELESS LAN**
- **2.0 TO 6.0 GHz T/R SWITCHING**
- **2.0 TO 6.0 GHz ANTENNA DIVERSITY SWITCHING**

**ORDERING INFORMATION**

PART NUMBER	ORDER NUMBER	PACKAGE	MARKING	SUPPLYING FORM
UPG2035T5F-E2-A	UPG2035T5F-E2-A	12-pin plastic QFN (Pb-Free)	2035	<ul style="list-style-type: none"> <li>• Embossed tape 8 mm wide</li> <li>• Pin 1 indicates roll-in direction of tape</li> <li>• Qty 3 kpcs/reel</li> </ul>

**Remark** To order evaluation samples, contact your nearby sales office.  
Part number for sample order: UPG2035T5F-A

**PIN CONNECTIONS AND INTERNAL BLOCK DIAGRAM**

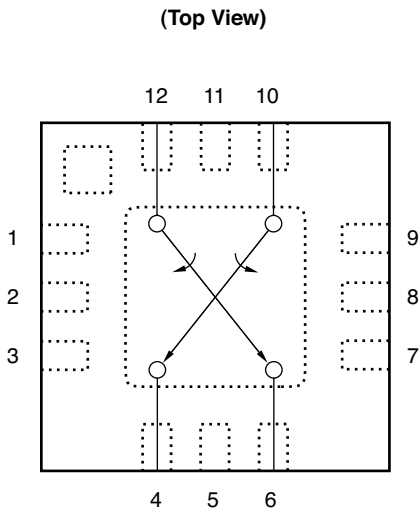

PIN NO.	PIN NAME	DESCRIPTION
1	NC	Ground
2	NC	Ground
3	V <sub>cont1</sub>	Control 1
4	ANT1	Antenna Port 1
5	NC	Ground
6	ANT2	Antenna Port 2
7	V <sub>cont2</sub>	Control 2
8	NC	Ground
9	NC	Ground
10	RX	Receive Port
11	NC	Ground
12	TX	Transmit Port
EXPOSED PAD	GND	Ground

**Remark** NC indicates functionally non-connected pins, but actual grounding is recommended.

**TRUTH TABLE**

V <sub>cont1</sub>	V <sub>cont2</sub>	ANT1-RX	ANT1-TX	ANT2-TX	ANT2-RX
2.7 to 5.0 V	0 ± 0.2 V	ON	OFF	ON	OFF
0 ± 0.2 V	2.7 to 5.0 V	OFF	ON	OFF	ON

**ABSOLUTE MAXIMUM RATINGS** (T<sub>A</sub> = +25°C, unless otherwise specified)

PARAMETER	SYMBOL	RATINGS	UNIT
Switch Control Voltage	V <sub>cont</sub>	-6.0 to +6.0 <sup>Note 1</sup>	V
Input Power	P <sub>in</sub>	+36	dBm
Total Power Dissipation	P <sub>tot</sub>	0.15 <sup>Note 2</sup>	W
Operating Ambient Temperature	T <sub>A</sub>	-45 to +85	°C
Storage Temperature	T <sub>stg</sub>	-55 to +150	°C

- Notes**
1.  $|V_{cont1} - V_{cont2}| \leq 6.0 \text{ V}$
  2. Mounted on double-sided copper-clad 50 × 50 × 1.6 mm epoxy glass PWB, T<sub>A</sub> = +85°C

**RECOMMENDED OPERATING RANGE** ( $T_A = +25^\circ\text{C}$ )

PARAMETER	SYMBOL	MIN.	TYP.	MAX.	UNIT
Operating Frequency 1	f1	2.4	–	2.5	GHz
Operating Frequency 2	f2	4.9	–	6.0	GHz
Switch Control Voltage (H)	V <sub>cont (H)</sub>	2.7	3.0	5.0	V
Switch Control Voltage (L)	V <sub>cont (L)</sub>	–0.2	0	0.2	V

**ELECTRICAL CHARACTERISTICS** ( $T_A = +25^\circ\text{C}$ , V<sub>cont</sub> = 3.0 V/0 V, Z<sub>O</sub> = 50 Ω, DC blocking capacitors value: 4 pF, Each port, unless otherwise specified)

PARAMETER	SYMBOL	TEST CONDITIONS	MIN.	TYP.	MAX.	UNIT
Insertion Loss 1	L <sub>INS1</sub>	f = 2.4 to 2.5 GHz	–	0.8	1.0	dB
Insertion Loss 2	L <sub>INS2</sub>	f = 4.9 to 6.0 GHz	–	1.2	1.4	dB
Isolation 1 (INPUT to OUTPUT)	ISL1	f = 2.4 to 2.5 GHz	25	34	–	dB
Isolation 2 (INPUT to OUTPUT)	ISL2	f = 4.9 to 6.0 GHz	25	33	–	dB
Isolation 3 (TX to RX, ANT1 to ANT2)	ISL3	f = 2.4 to 2.5 GHz	17	24	–	dB
Isolation 4 (TX to RX, ANT1 to ANT2)	ISL4	f = 4.9 to 6.0 GHz	17	22	–	dB
Input and Output Return Loss 1	RL1	f = 2.4 to 2.5 GHz	–	15	–	dB
Input and Output Return Loss 2	RL2	f = 4.9 to 6.0 GHz	–	15	–	dB
Switch Control Current 1	I <sub>cont 1</sub>	f = 2.4 to 2.5 GHz	–	0.7	1.5	μA
Switch Control Current 2	I <sub>cont 2</sub>	f = 4.9 to 6.0 GHz	–	0.7	1.5	μA
1 dB Gain Compression Input Power	P <sub>in (1 dB)</sub>	f = 2.4 to 2.5 GHz	–	31	–	dBm
		f = 4.9 to 6.0 GHz	–	30	–	
3rd Order Distortion Input Intercept Point 1	IIP <sub>3 1</sub>	f = 2.4 to 2.5 GHz	–	45	–	dBm
3rd Order Distortion Input Intercept Point 2	IIP <sub>3 2</sub>	f = 4.9 to 6.0 GHz	–	45	–	dBm
Switch Control Speed 1	t <sub>sw 1</sub>	f = 2.4 to 2.5 GHz, t <sub>RISE</sub> /t <sub>FALL</sub> (10/90% RF)	–	50	–	ns
Switch Control Speed 2	t <sub>sw 2</sub>	f = 4.9 to 6.0 GHz, t <sub>RISE</sub> /t <sub>FALL</sub> (10/90% RF)	–	50	–	ns

EVALUATION CIRCUIT

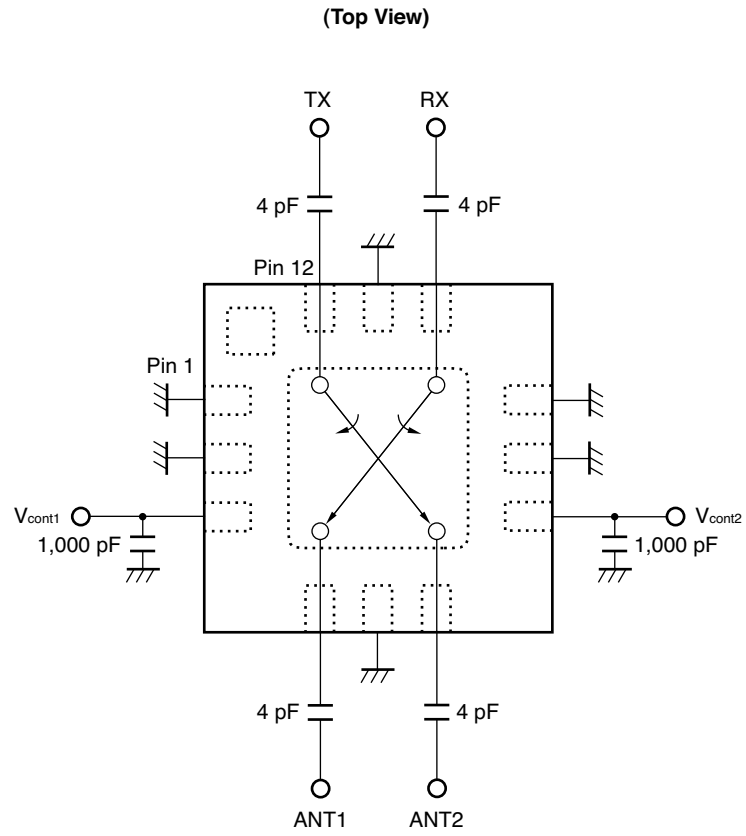

This application circuit and its parameters are for reference only.

## ILLUSTRATION OF THE TEST CIRCUIT ASSEMBLED ON EVALUATION BOARD

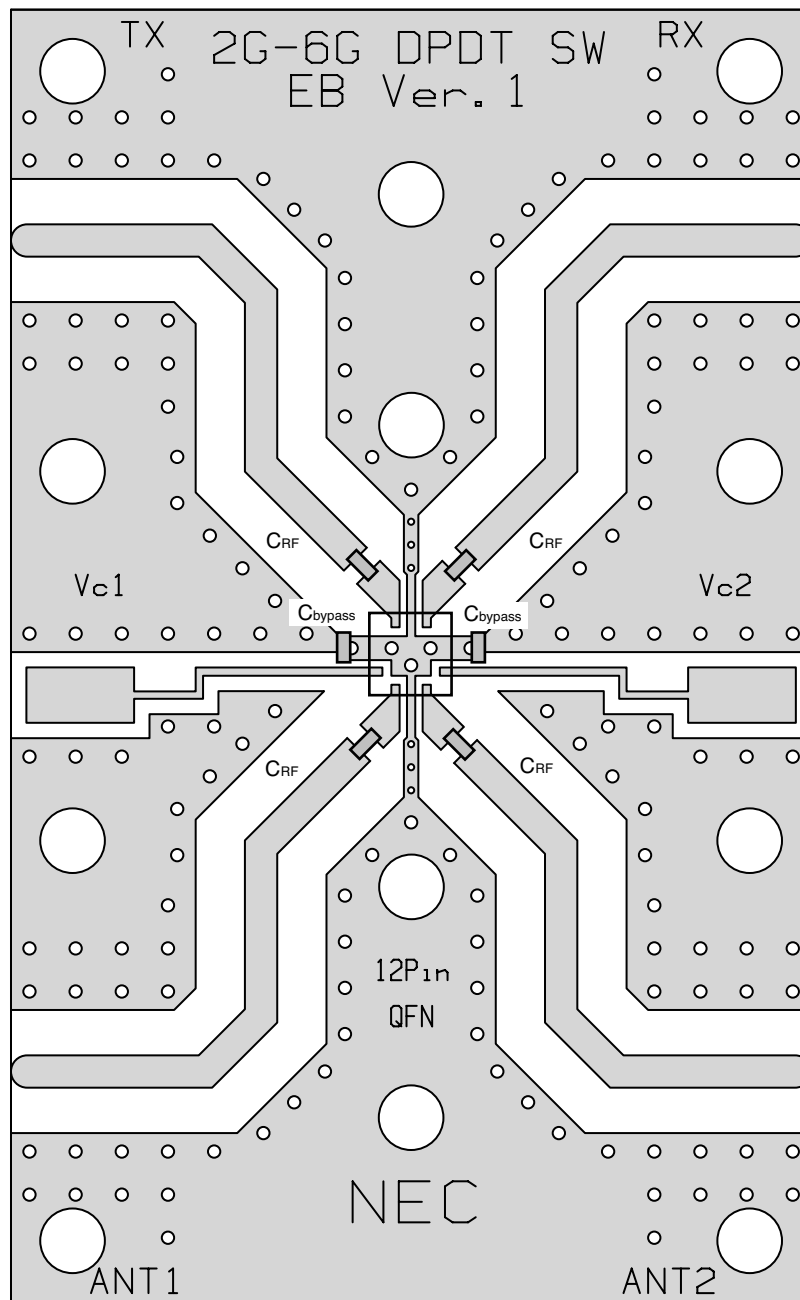

## USING THE NEC EVALUATION BOARD

SYMBOL	FORM	RATING	PART NUMBER	MANUFACTURER
CRF	Chip Capacitor	4 pF	GRM1552C1H4R0CZ01B	muRata
C <sub>bypass</sub>	Chip Capacitor	1 000 pF	GRM155B11H102KA01B	muRata
-	PC Terminal	-	A2-2PA-2.54DSA	Hirose
-	RF Connector	-	142-0721-821	Johnson
-	PWB	-	RO4003 (t = 0.51 mm)	Rogers

**TYPICAL CHARACTERISTICS** ( $T_A = +25^\circ\text{C}$ ,  $V_{\text{cont}} = 3.0\text{ V/0 V}$ ,  $Z_0 = 50\ \Omega$ , DC block capacitor = 4 pF using test fixture, unless otherwise specified)

**TX-ANT1 INSERTION LOSS vs. FREQUENCY**  
(When TX-ANT1 and ANT2-RX are ON)

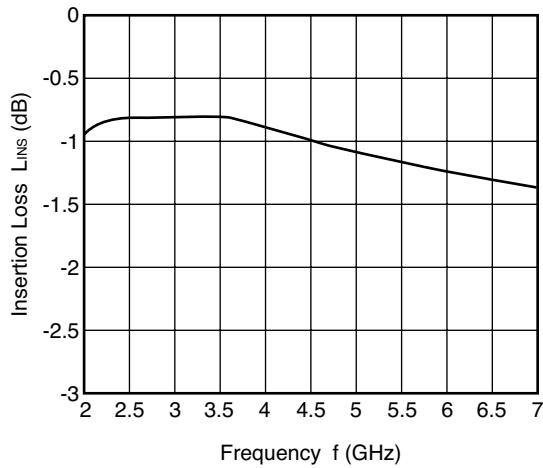

**ANT1-RX INSERTION LOSS vs. FREQUENCY**  
(When TX-ANT2 and ANT1-RX are ON)

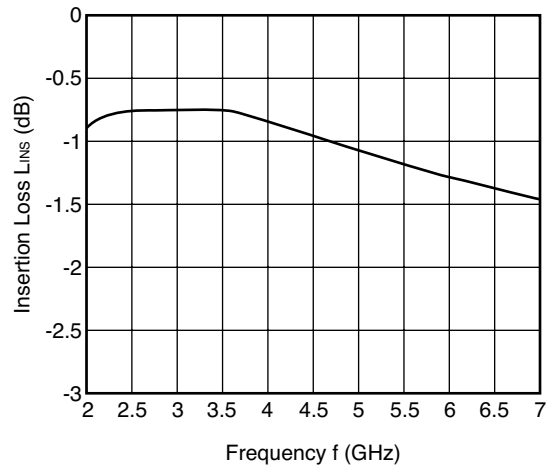

**TX-ANT2 INSERTION LOSS vs. FREQUENCY**  
(When TX-ANT2 and ANT1-RX are ON)

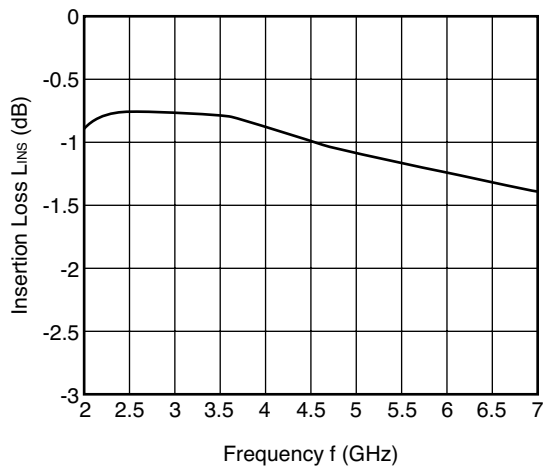

**ANT2-RX INSERTION LOSS vs. FREQUENCY**  
(When TX-ANT1 and ANT2-RX are ON)

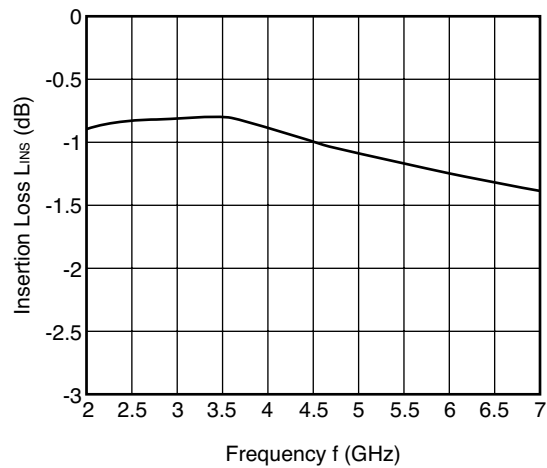

**TX-RX ISOLATION vs. FREQUENCY**  
(When TX-ANT2 and ANT1-RX are ON)

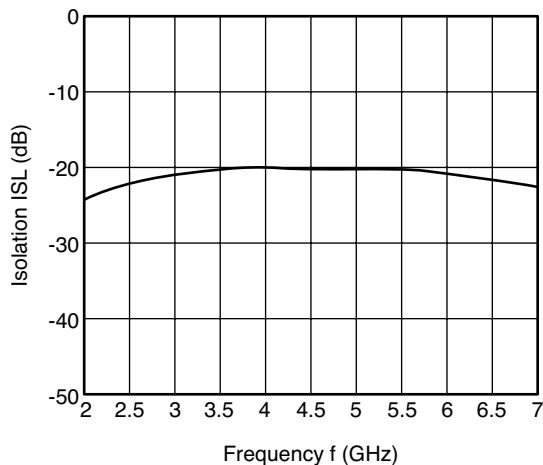

**TX-RX ISOLATION vs. FREQUENCY**  
(When TX-ANT1 and ANT2-RX are ON)

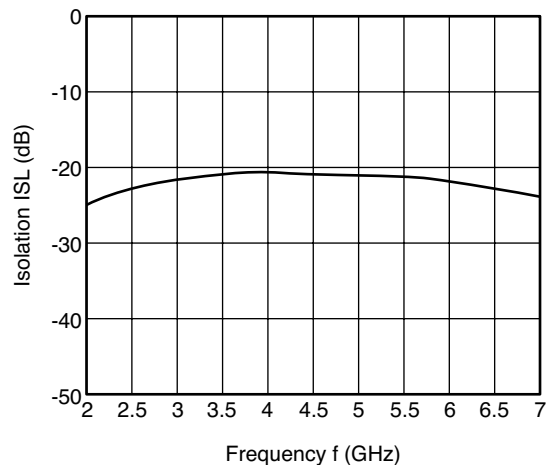

**Remark** The graphs indicate nominal characteristics.

TX-ANT1 ISOLATION vs. FREQUENCY  
(When TX-ANT2 and ANT1-RX are ON)

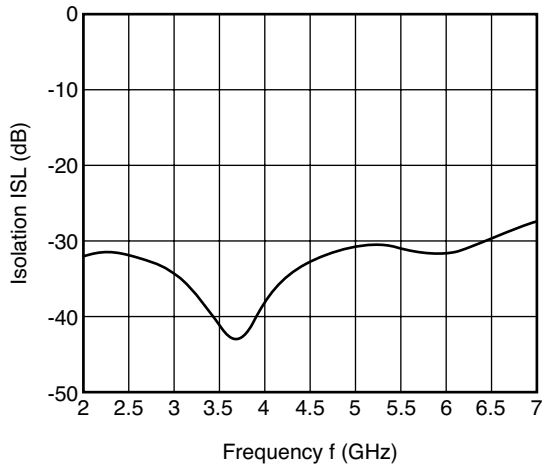

ANT1-RX ISOLATION vs. FREQUENCY  
(When TX-ANT1 and ANT2-RX are ON)

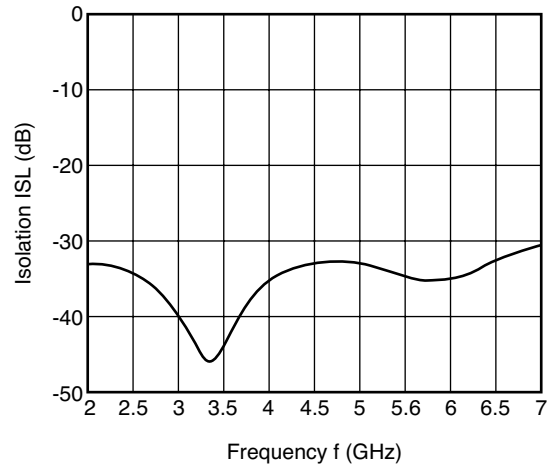

TX-ANT2 ISOLATION vs. FREQUENCY  
(When TX-ANT1 and ANT2-RX are ON)

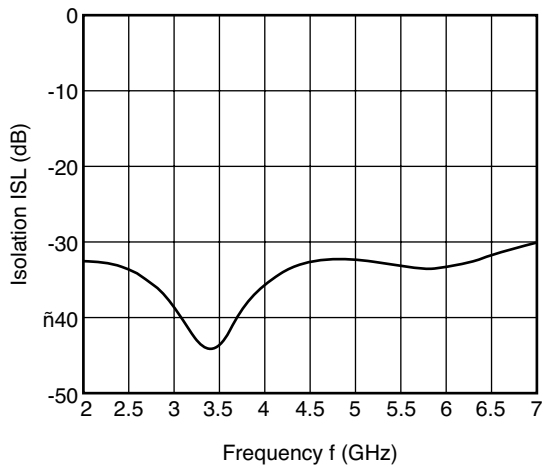

ANT2-RX ISOLATION vs. FREQUENCY  
(When TX-ANT2 and ANT1-RX are ON)

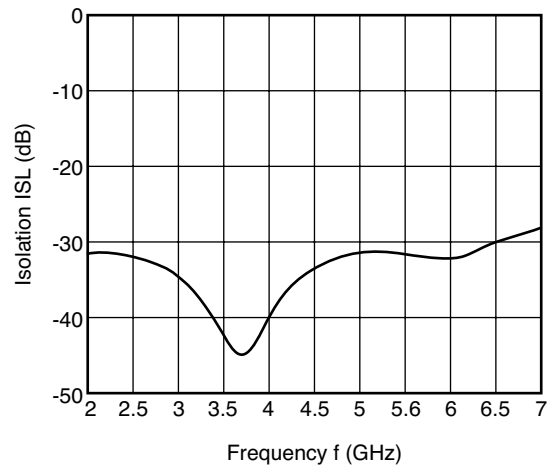

TX-ANT1 INPUT RETURN LOSS vs. FREQUENCY  
(When TX-ANT1 and ANT2-RX are ON)

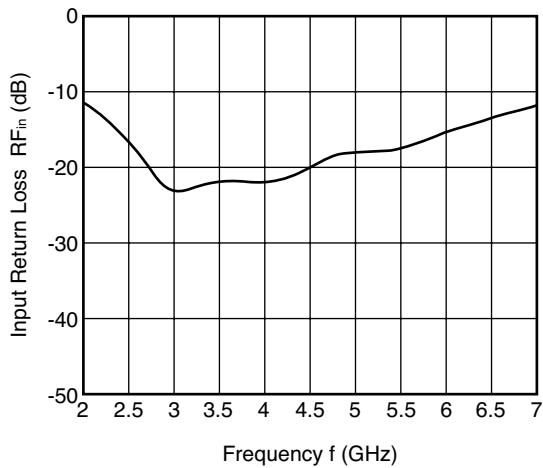

ANT1-RX OUTPUT RETURN LOSS vs. FREQUENCY  
(When TX-ANT2 and ANT1-RX are ON)

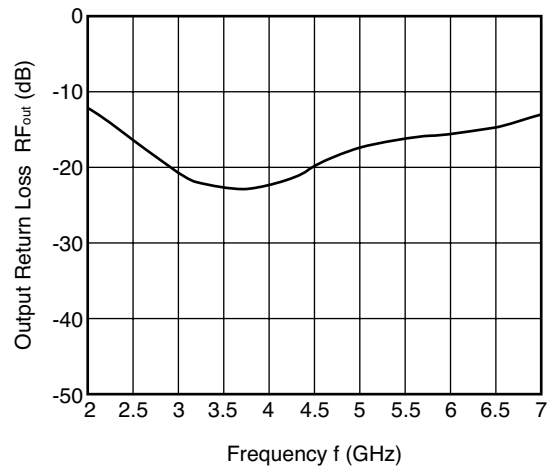

**Remark** The graphs indicate nominal characteristics.

TX-ANT2 INPUT RETURN LOSS vs. FREQUENCY  
(When TX-ANT2 and ANT1-RX are ON)

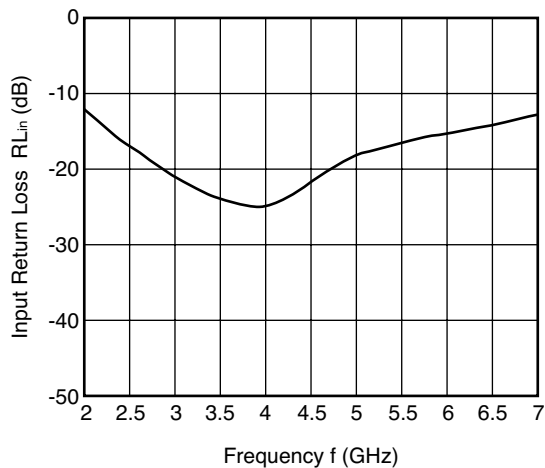

ANT2-RX OUTPUT RETURN LOSS vs. FREQUENCY  
(When TX-ANT1 and ANT2-RX are ON)

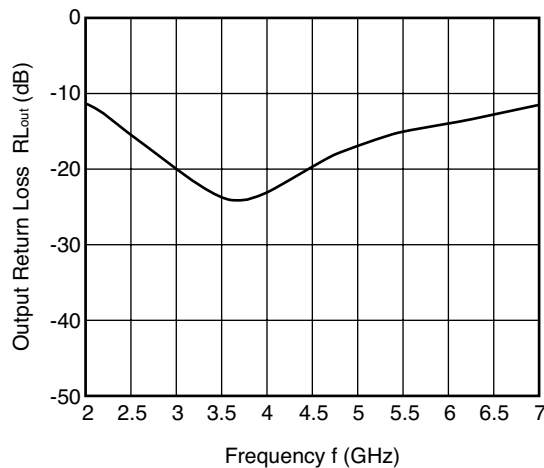

TX-ANT1 OUTPUT RETURN LOSS vs. FREQUENCY  
(When TX-ANT1 and ANT2-RX are ON)

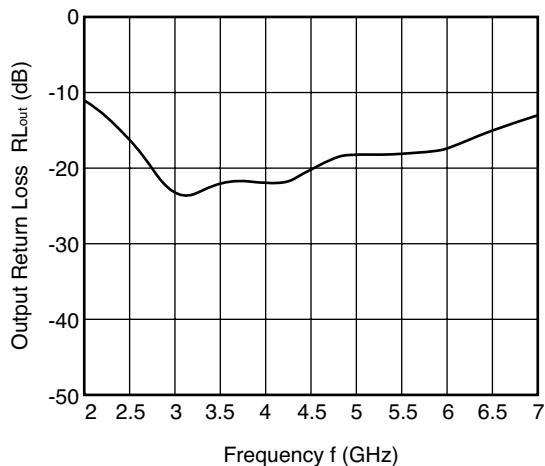

ANT1-RX INPUT RETURN LOSS vs. FREQUENCY  
(When TX-ANT2 and ANT1-RX are ON)

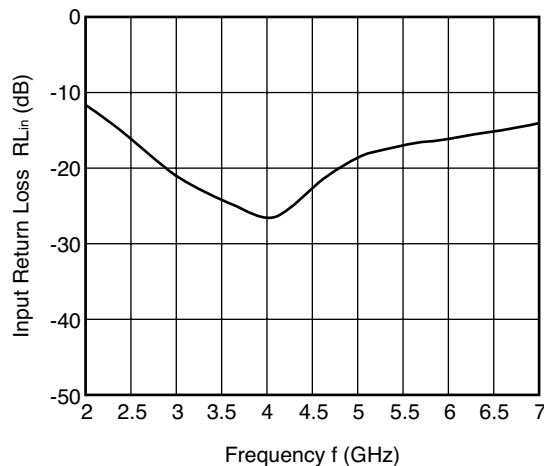

TX-ANT2 OUTPUT RETURN LOSS vs. FREQUENCY  
(When TX-ANT2 and ANT1-RX are ON)

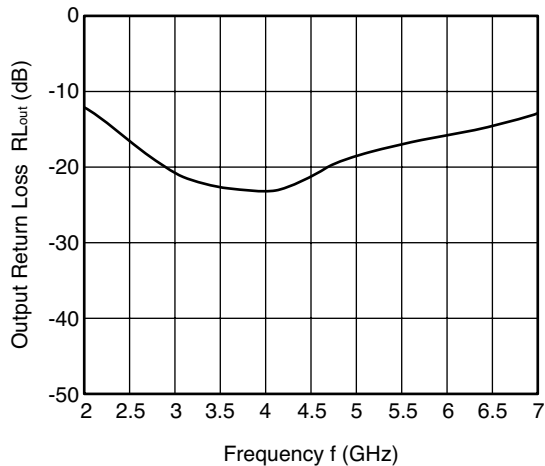

ANT2-RX INPUT RETURN LOSS vs. FREQUENCY  
(When TX-ANT1 and ANT2-RX are ON)

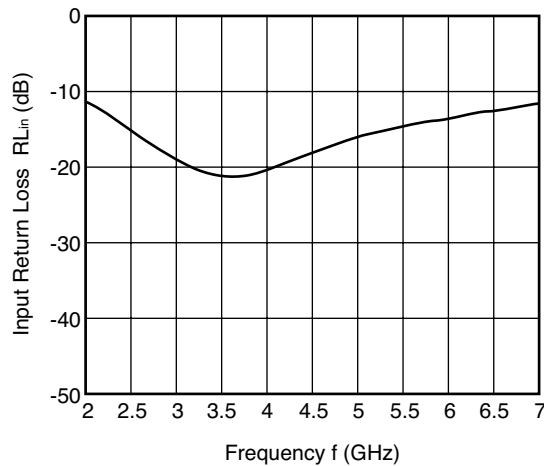



OUTPUT POWER vs. INPUT POWER  
(f = 2.4 GHz)

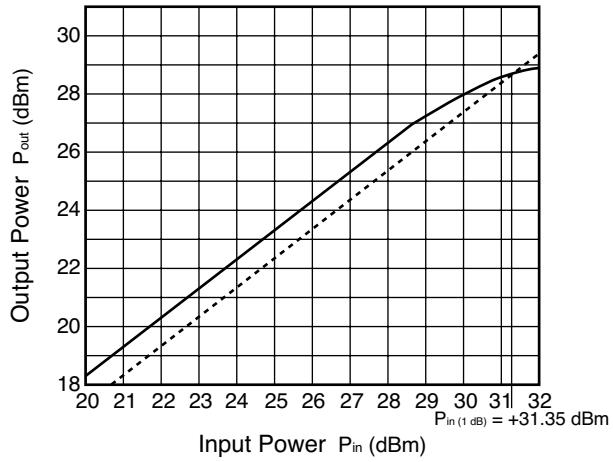

OUTPUT POWER vs. INPUT POWER  
(f = 5.8 GHz)

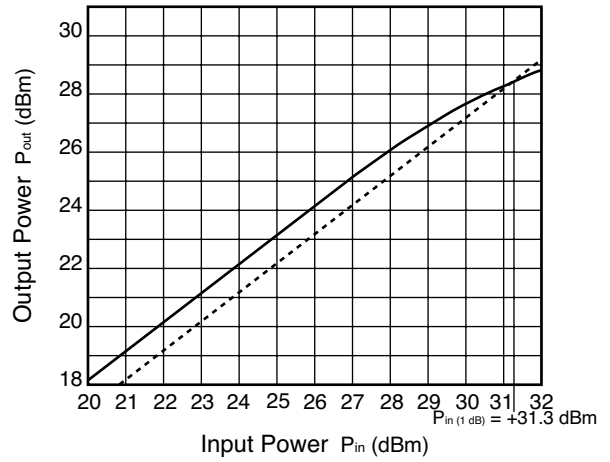

PACKAGE DIMENSIONS

12-PIN QFN (UNIT:mm)

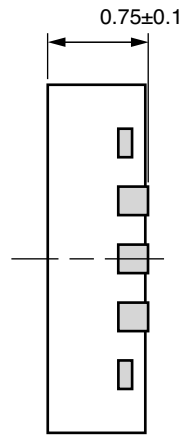
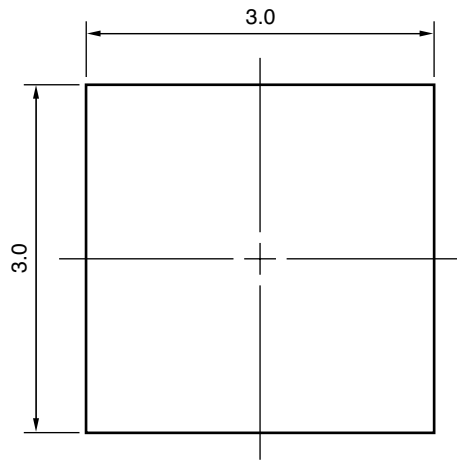

(Bottom View)

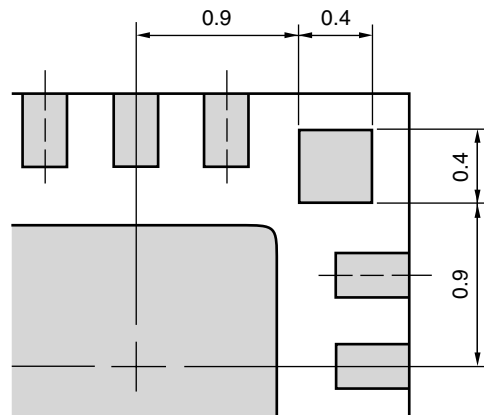
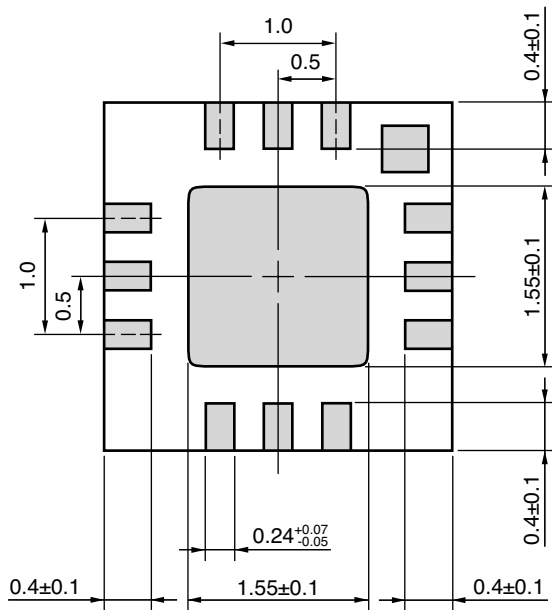

Dimensions of pin No.1 indication

**RECOMMENDED SOLDERING CONDITIONS**

This product should be soldered and mounted under the following recommended conditions. For soldering methods and conditions other than those recommended below, contact your nearby sales office.

Soldering Method	Soldering Conditions	Condition Symbol
Infrared Reflow	Peak temperature (package surface temperature) : 260°C or below Time at peak temperature : 10 seconds or less Time at temperature of 220°C or higher : 60 seconds or less Preheating time at 120 to 180°C : 120±30 seconds Maximum number of reflow processes : 3 times Maximum chlorine content of rosin flux (% mass) : 0.2%(Wt.) or below	IR260
Wave Soldering	Peak temperature (molten solder temperature) : 260°C or below Time at peak temperature : 10 seconds or less Preheating temperature (package surface temperature) : 120°C or below Maximum number of flow processes : 1 time Maximum chlorine content of rosin flux (% mass) : 0.2%(Wt.) or below	WS260
Partial Heating	Peak temperature (pin temperature) : 350°C or below Soldering time (per side of device) : 3 seconds or less Maximum chlorine content of rosin flux (% mass) : 0.2%(Wt.) or below	HS350

**Caution** Do not use different soldering methods together (except for partial heating).

Life Support Applications

These NEC products are not intended for use in life support devices, appliances, or systems where the malfunction of these products can reasonably be expected to result in personal injury. The customers of CEL using or selling these products for use in such applications do so at their own risk and agree to fully indemnify CEL for all damages resulting from such improper use or sale.

**CEL** California Eastern Laboratories, Your source for NEC RF, Microwave, Optoelectronic, and Fiber Optic Semiconductor Devices.  
 4590 Patrick Henry Drive • Santa Clara, CA 95054-1817 • (408) 988-3500 • FAX (408) 988-0279 • [www.cel.com](http://www.cel.com)

DATA SUBJECT TO CHANGE WITHOUT NOTICE

05/04/2005

Subject: Compliance with EU Directives

CEL certifies, to its knowledge, that semiconductor and laser products detailed below are compliant with the requirements of European Union (EU) Directive 2002/95/EC Restriction on Use of Hazardous Substances in electrical and electronic equipment (RoHS) and the requirements of EU Directive 2003/11/EC Restriction on Penta and Octa BDE.

CEL Pb-free products have the same base part number with a suffix added. The suffix –A indicates that the device is Pb-free. The –AZ suffix is used to designate devices containing Pb which are exempted from the requirement of RoHS directive (\*). In all cases the devices have Pb-free terminals. All devices with these suffixes meet the requirements of the RoHS directive.

This status is based on CEL’s understanding of the EU Directives and knowledge of the materials that go into its products as of the date of disclosure of this information.

Restricted Substance per RoHS	Concentration Limit per RoHS (values are not yet fixed)	Concentration contained in CEL devices	
		-A	-AZ
Lead (Pb)	< 1000 PPM	Not Detected	(*)
Mercury	< 1000 PPM	Not Detected	
Cadmium	< 100 PPM	Not Detected	
Hexavalent Chromium	< 1000 PPM	Not Detected	
PBB	< 1000 PPM	Not Detected	
PBDE	< 1000 PPM	Not Detected	

If you should have any additional questions regarding our devices and compliance to environmental standards, please do not hesitate to contact your local representative.

**Important Information and Disclaimer:** Information provided by CEL on its website or in other communications concerning the substance content of its products represents knowledge and belief as of the date that it is provided. CEL bases its knowledge and belief on information provided by third parties and makes no representation or warranty as to the accuracy of such information. Efforts are underway to better integrate information from third parties. CEL has taken and continues to take reasonable steps to provide representative and accurate information but may not have conducted destructive testing or chemical analysis on incoming materials and chemicals. CEL and CEL suppliers consider certain information to be proprietary, and thus CAS numbers and other limited information may not be available for release.

In no event shall CEL’s liability arising out of such information exceed the total purchase price of the CEL part(s) at issue sold by CEL to customer on an annual basis.

See CEL Terms and Conditions for additional clarification of warranties and liability.

## **О компании**

ООО "ТрейдЭлектроникс" - это оперативные поставки широкого спектра электронных компонентов отечественного и импортного производства напрямую от производителей и с крупнейших мировых складов. Реализуемая нашей компанией продукция насчитывает более полумиллиона наименований.

Благодаря этому наша компания предлагает к поставке практически не ограниченный ассортимент компонентов как оптовыми, мелкооптовыми партиями, так и в розницу.

Наличие собственной эффективной системы логистики обеспечивает надежную поставку продукции по конкурентным ценам в точно указанные сроки.

Срок поставки со стоков в **Европе и Америке – от 3 до 14 дней.**

Срок поставки из **Азии – от 10 дней.**

Благодаря развитой сети поставщиков, помогаем в поиске и приобретении экзотичных или снятых с производства компонентов.

Предоставляем спец цены на элементы для создания инженерных сэмплов.

**Упорный труд, качественный результат дают нам право быть уверенными в себе и надежными для наших клиентов.**

### **Наша компания это:**

- Гарантия качества поставляемой продукции
- Широкий ассортимент
- Минимальные сроки поставок
- Техническая поддержка
- Подбор комплектации
- Индивидуальный подход
- Гибкое ценообразование

Наша организация особенно сильна в поставках модулей, микросхем, пассивных компонентов, ксайленсах (XC), EPF, EPM и силовой электроники.

Большой выбор предлагаемой продукции, различные виды оплаты и доставки, позволят Вам сэкономить время и получить максимум выгоды от сотрудничества с нами!

## Перечень производителей, продукцию которых мы поставляем на российский рынок



С удовольствием будем прорабатывать для Вас поставки всех необходимых компонентов по текущим запросам для скорейшего выявления групп элементов, по которым сотрудничество именно с нашей компанией будет для Вас максимально выгодным!

С уважением,

Менеджер отдела продаж ООО

«Трейд Электроникс»

Шишлаков Евгений

8 (495)668-30-28 доб 169

manager28@tradeelectronics.ru

<http://www.tradeelectronics.ru/>