

SINGLE TURN WIREWOUND TRIMMERS

λ-6/λ-13

RoHS compliant

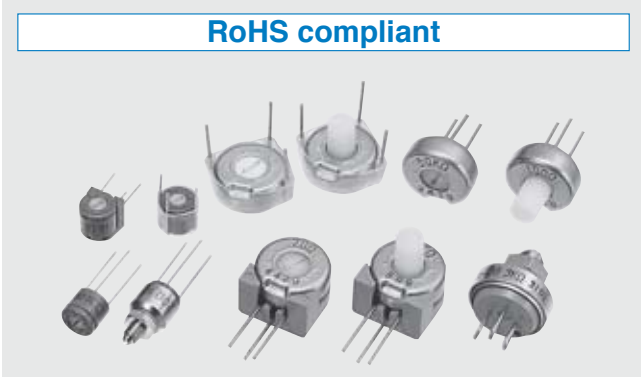

INTERNAL STRUCTURE λ-13T

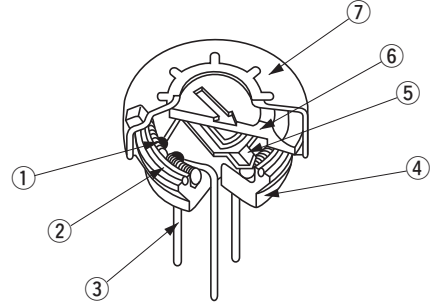

	Part name	Material	Flammability
①	Resistive element	—	—
②	“O” ring	Silicone rubber	UL-94HB
③	Terminal pin	Nickel, Gold-plated	—
④	Base	DAP	UL-94HB
⑤	Wiper	Copper alloy, Palladium-plated	—
⑥	Wheel	Polyoxymethylene	UL-94HB
⑦	Cover	Stainless steel	—

FEATURES

- Low temperature coefficient of resistance
- Low contact resistance

PART NUMBER DESIGNATION

λ - 6 T 10 Ω
(1 1 0 6)

Series name

λ - 6 : φ 6.6 mm λ - 13 : φ 13.5 mm
(1106) (1113)

※ “λ” may be replaced by 11 for type writing conveniences.

Product shape

T : Top adjustment	TR : Top adjustment with knob
S : Side adjustment	SR : Side adjustment with knob
F : Rear adjustment	FR : Rear adjustment with knob
B : Panel mount	

Resistance value

※ Please refer to the LIST OF PART NUMBERS when placing orders.

λ-6/λ-13 WIREWOUND TRIMMERS

LIST OF PART NUMBERS

Adjustment position	Dimension	
	φ 6.6 mm	φ 13.5 mm
Top adjustment	λ-6T (1106T)	λ-13T (1113T)
Top adjustment with knob		λ-13TR (1113TR)
Side adjustment	λ-6S (1106S)	λ-13S (1113S)
Side adjustment with knob		λ-13SR (1113SR)
Panel mount	λ-6B (1106B)	λ-13B (1113B)
Rear adjustment	λ-6F (1106F)	λ-13F (1113F)
Rear adjustment with knob		λ-13FR (1113FR)

☐ : Not manufactured

※Verify the above part numbers <Nominal resistance values> (Fig. 1) when placing orders.

<Nominal resistance values>

	λ-6 (1106)				λ-13 (1113)						
	T	S	B	F	T	TR	S	SR	B	F	FR
10 Ω	●	●	☞	☞	●	☞	●	☞	●	☞	☞
20 Ω	●	●	☞	☞	●	☞	●	☞	●	☞	☞
50 Ω	●	●	☞	☞	●	☞	●	☞	●	☞	☞
100 Ω	●	●	☞	☞	●	☞	●	☞	●	☞	☞
200 Ω	●	●	☞	☞	●	☞	●	☞	●	☞	☞
500 Ω	●	●	☞	☞	●	☞	●	☞	●	☞	☞
1 kΩ	●	●	☞	☞	●	☞	●	☞	●	☞	☞
2 kΩ	●	●	☞	☞	●	☞	●	☞	●	☞	☞
5 kΩ	●	●	☞	☞	●	☞	●	☞	●	☞	☞
10 kΩ	●	●	☞	☞	●	☞	●	☞	●	☞	☞
20 kΩ	●	●	☞	☞	●	☞	●	☞	●	☞	☞
25 kΩ					☞	☞	☞	☞	☞	☞	☞
30 kΩ	☞	☞	☞	☞							
50 kΩ					●	☞	●	☞	●	☞	☞
100 kΩ					●	☞	●	☞	●	☞	☞

Fig. 1

The products indicated by ☞ mark are manufactured upon receipt of order basis.

ELECTRICAL CHARACTERISTICS

	λ-6 (1106)	λ-13 (1113)
Nominal resistance range	10 Ω ~ 30 kΩ	10 Ω ~ 100 kΩ
Resistance tolerance	± 10 %	
Power rating ※1	0.37 W (70 °C) 0 W (120 °C)	0.75 W (70 °C) 0 W (120 °C)
Electrical continuity	Continuous for full mechanical range	
End resistance	2 % or 1 Ω, whichever is greater	
Resolution	1.42 ~ 0.14 %	1.07 ~ 0.08 %
Peak noise	100 Ω (ENR) maximum	
Operating temp. range	-55 ~ 120 °C	
Temp. coefficient	± 50 10 ⁻⁶ /°C maximum	
Insulation resistance	1000 MΩ minimum (DC500 V)	
Dielectric strength	900 Vrms, 1 min (Room conditions)	
Net weight	Approx. 0.34 g (λ-6T) Approx. 0.47 g (λ-6S) Approx. 1.41 g (λ-6B) Approx. 0.39 g (λ-6F)	Approx. 1.60 g (λ-13T) Approx. 2.59 g (λ-13S) Approx. 5.16 g (λ-13B) Approx. 1.73 g (λ-13TR) Approx. 2.72 g (λ-13SR) Approx. 1.86 g (λ-13F) Approx. 1.93 g (λ-13FR)

MECHANICAL CHARACTERISTICS

	λ-6 (1106)	λ-13 (1113)
Mechanical angle	310 ° (1 turn)	
Operating torque	7.85 mN·m {80 gf·cm} maximum	19.61 mN·m {200 gf·cm} maximum
Stop strength	49.04 mN·m {500 gf·cm} minimum	98.07 mN·m {1 kgf·cm} minimum
Rotational life	200 cycles [ΔR/R ≤ 2 %]	
Terminal strength	8.89 N {907 gf} minimum (Tensile strength MIL-R-27208)	

{ } : Reference only

※1 Rated power is given for the maximum input voltage (V) and maximum wiper current (mA) for the resistance value.

λ-6/λ-13 WIREWOUND TRIMMERS

ENVIRONMENTAL CHARACTERISTICS

(In accordance with MIL-R-27208)

Test item	Test conditions	Specifications
Thermal shock	-65 ~ 125 °C, 5 cycles	[$\Delta R/R \leq 1\% + 0.05\Omega$] [S.S. $\leq 1\% + \text{Resolution}$]
Humidity	80 ~ 98 %, 240 h	[$\Delta R/R \leq 1\% + 0.05\Omega$]
Shock	981 m/s ²	[$\Delta R/R \leq 1\% + 0.05\Omega$] [S.S. $\leq 1\% + \text{Resolution}$]
Vibration	Acceleration 196 m/s ² , 10 ~ 2000 Hz	[$\Delta R/R \leq 1\% + 0.05\Omega$] [S.S. $\leq 1\% + \text{Resolution}$]
Load life	70 °C (Full load), 1000 h	[$\Delta R/R \leq 2\%$] [S.S. $\leq 2\% + \text{Resolution}$]
Low temp. operation	-55 °C, 2 h	[$\Delta R/R \leq 1\% + 0.05\Omega$] [S.S. $\leq 1\% + \text{Resolution}$]
High temp. exposure	120 °C, 250 h	[$\Delta R/R \leq 1\% + 0.05\Omega$] [S.S. $\leq 1\% + \text{Resolution}$]
Immersion seal	85 °C	No leaks
Salt spray	No corrosion	—
Soldering heat	350 °C, 3 s	—

$\Delta R/R$: Change in total resistance
S.S. : Setting stability

RESOLUTION CHARACTERISTICS

Nominal resistance values (Ω)	Resolution (%)	
	λ -6 (1106)	λ -13 (1113)
10	1.42	1.07
20	1.14	0.83
50	0.91	0.71
100	0.74	0.57
200	0.56	0.42
500	0.54	0.35
1 k	0.48	0.40
2 k	0.34	0.27
5 k	0.28	0.20
10 k	0.22	0.19
20 k	0.17	0.12
25 k	—	0.11
30 k	0.14	—
50 k	—	0.10
100 k	—	0.08

λ-6/λ-13 WIREWOUND TRIMMERS

OUTLINE DIMENSIONS

Unless otherwise specified, tolerance : ± 0.2 (Unit : mm)

● λ-6T (1106T) Top adjustment

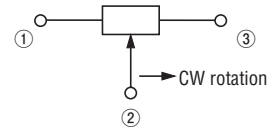
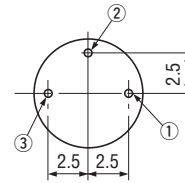
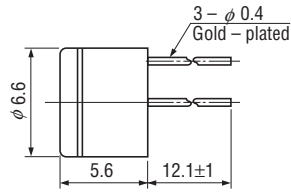
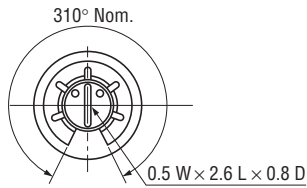

● λ-6S (1106S) Side adjustment

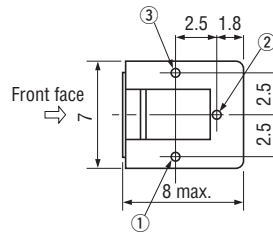
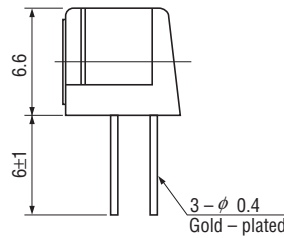
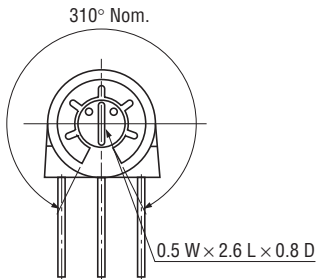

● λ-6B (1106B) Panel mount

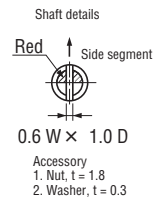
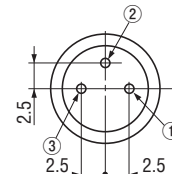
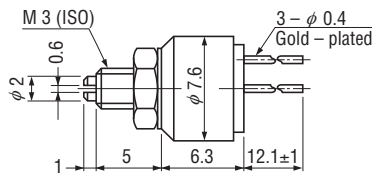
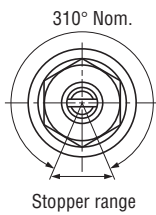

● λ-6F (1106F) Rear adjustment

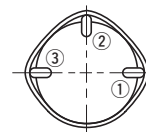
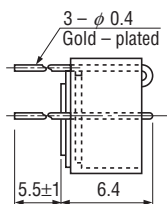
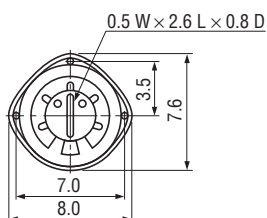

λ-6/λ-13 WIREWOUND TRIMMERS

OUTLINE DIMENSIONS

Unless otherwise specified, tolerance : ± 0.2 (Unit : mm)

● λ-13T (1113T) Top adjustment

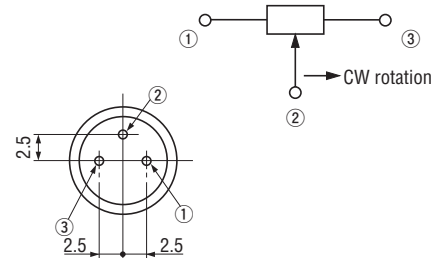
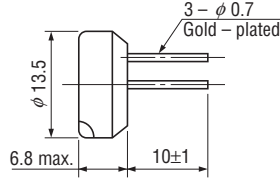
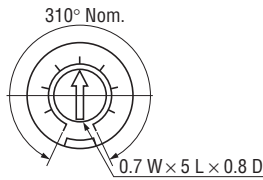

● λ-13TR (1113TR) Top adjustment with knob

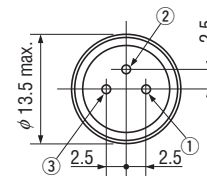
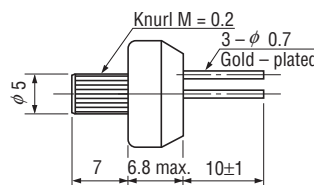
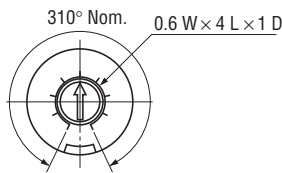

● λ-13S (1113S) Side adjustment

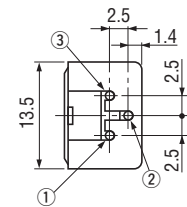
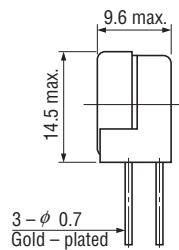
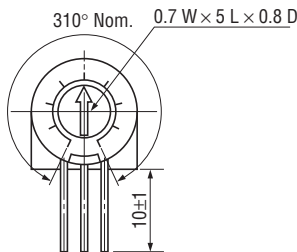

● λ-13SR (1113SR) Side adjustment with knob

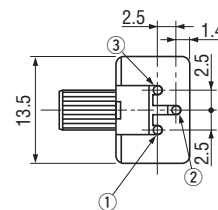
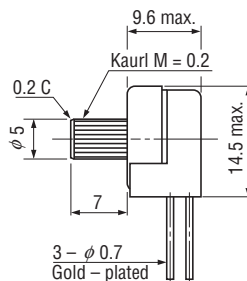
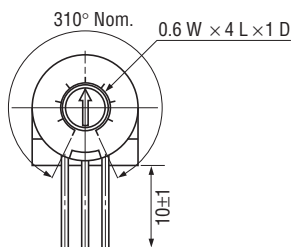

● λ-13B (1113B) Panel mount

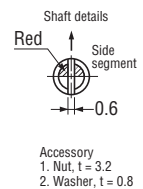
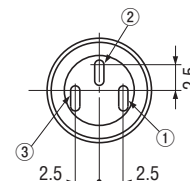
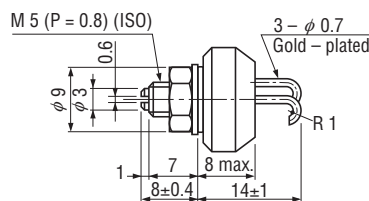
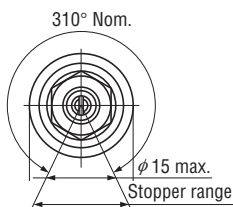

λ-6/λ-13 WIREWOUND TRIMMERS

OUTLINE DIMENSIONS

● λ-13F (1113F) Rear adjustment

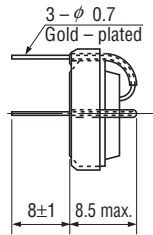
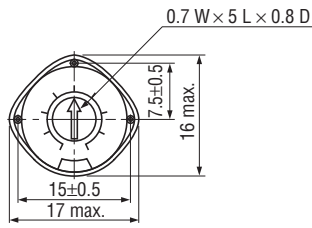

Unless otherwise specified, tolerance : ± 0.2 (Unit : mm)

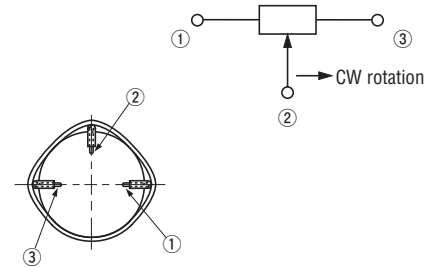

● λ-13FR (1113FR) Rear adjustment with knob

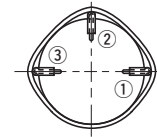
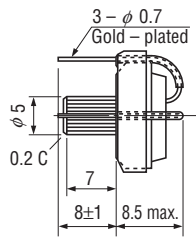
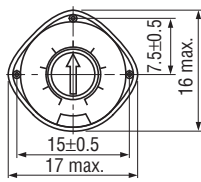

О компании

ООО "ТрейдЭлектроникс" - это оперативные поставки широкого спектра электронных компонентов отечественного и импортного производства напрямую от производителей и с крупнейших мировых складов. Реализуемая нашей компанией продукция насчитывает более полумиллиона наименований.

Благодаря этому наша компания предлагает к поставке практически не ограниченный ассортимент компонентов как оптовыми, мелкооптовыми партиями, так и в розницу.

Наличие собственной эффективной системы логистики обеспечивает надежную поставку продукции по конкурентным ценам в точно указанные сроки.

Срок поставки со стоков в **Европе и Америке – от 3 до 14 дней.**

Срок поставки из **Азии – от 10 дней.**

Благодаря развитой сети поставщиков, помогаем в поиске и приобретении экзотичных или снятых с производства компонентов.

Предоставляем спец цены на элементы для создания инженерных сэмплов.

Упорный труд, качественный результат дают нам право быть уверенными в себе и надежными для наших клиентов.

Наша компания это:

- Гарантия качества поставляемой продукции
- Широкий ассортимент
- Минимальные сроки поставок
- Техническая поддержка
- Подбор комплектации
- Индивидуальный подход
- Гибкое ценообразование

Наша организация особенно сильна в поставках модулей, микросхем, пассивных компонентов, ксайленсах (XC), EPF, EPM и силовой электроники.

Большой выбор предлагаемой продукции, различные виды оплаты и доставки, позволят Вам сэкономить время и получить максимум выгоды от сотрудничества с нами!

Перечень производителей, продукцию которых мы поставляем на российский рынок

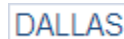

С удовольствием будем прорабатывать для Вас поставки всех необходимых компонентов по текущим запросам для скорейшего выявления групп элементов, по которым сотрудничество именно с нашей компанией будет для Вас максимально выгодным!

С уважением,

Менеджер отдела продаж ООО

«Трейд Электроникс»

Шишлаков Евгений

8 (495)668-30-28 доб 169

manager28@tradeelectronics.ru

<http://www.tradeelectronics.ru/>