



Logic Diagram

### FEATURES:

- 32-Bit microprocessor
- RAD-PAK® radiation-hardened against natural space radiation
- Total dose hardness:
  - >100 Krad (Si), dependent upon space mission
- Single event effect:
  - $SEL_{TH} = 37-60 \text{ MeV/mg/cm}^2$
  - $SEU_{TH} = 3.4 \text{ MeV/mg/cm}^2$
  - SEU Cross section  $1E-3 \text{ cm}^2/\text{bit}$
- Package:
  - 164 Pin RAD-PAK® quad flat pack
- 8, 16, 32-Bit data types
- 8 general purpose 32-Bit registers
- Hardware debugging support
- Very large address space:
  - 4 gigabyte physical
  - 64 terabyte Virtual
  - 4 gigabyte maximum segment size
- Integrated memory management unit
  - Virtual memory support
  - Four levels of protection
  - Fully compatible with 80C286
- Optimized for system development
  - Pipelined instructions
  - On-chip caches support address translation
  - 32 megabytes/sec bus bandwidth

### DESCRIPTION:

Maxwell Technologies' 80386DX high performance 32-bit microprocessor features a greater than 100 krad (Si) total dose tolerance, dependent upon space mission. It is designed for very high performance and multitasking operating systems. The integrated memory management and protection architecture includes address translation registers, multitasking hardware and a protection mechanism to support operating systems. The 80386DX allows simultaneous running of multiple operations. In addition, the 80386DX is capable of execution at sustained rates of between 3 and 4 million instructions per second. It offers new testability and debugging features, including a self-test and direct access to the page translation cache.

Maxwell Technologies' patented RAD-PAK® packaging technology incorporates radiation shielding in the microcircuit package. It eliminates the need for box shielding while providing the required radiation shielding for a lifetime in orbit or space mission. In a GEO orbit, RAD-PAK provides greater than 100 krad (Si) radiation dose tolerance. This product is available with screening up to Class S.

TABLE 1. 80386DX PIN DESCRIPTION

PIN	SYMBOL	DESCRIPTION
1-7, 9, 10, 12, 13, 16, 17, 20, 21, 24, 146-149, 152-154, 156-159, 161-163	A16-A11, A9, A10, A7, A8, A5, A6, A3, A4, A2, A31-A28, A27-A25, A23-A22, A20-A18	Address Bus
8, 18, 19, 22, 23, 25, 28-30, 33, 36, 38-40, 47, 48, 65, 66, 68, 73, 76, 77, 82, 84, 86, 88, 103, 106, 107, 114, 125, 126, 129, 130, 133, 134, 145, 155, 160, 164	NC	Not Connected
11, 15, 27, 32, 35, 43, 51, 53, 55, 57, 61, 70, 92, 95, 100, 111, 118, 122, 138, 142, 151	V <sub>SS</sub>	Ground
14, 26, 31, 34, 44, 50, 52, 54, 56, 58, 62, 69, 91, 96, 99, 110, 117, 137, 141, 150,	V <sub>CC</sub>	Power Supply
37	INTR	Interrupt Request
41	NMI	Non-Maskable Interrupt Request
42	PEREQ	Processor Extension Request
45	ERROR	Error Status
46	RESET	Reset
49	BUSY	Busy Status
59	LOCK	Bus Lock
60	W/R	Write/ Read
63	M/I $\bar{O}$	Memory I/O
64	D/C	Data Control
67, 71, 72, 74	BE $\bar{2}$ , BE $\bar{0}$ , BE $\bar{3}$ , BE $\bar{1}$	Byte Enables
78	BS16	Bus Size 16
75	NA	Next Address
79	HOLD	Bus Hold Request
80	CLK2	CPU Clock 2
81	ADS	Address Staus
83	READY	Bus Ready Input
85, 87, 89, 90, 93, 94, 97, 98, 102, 104, 105, 108, 109, 112, 113, 115, 116, 119, 120, 121, 123, 124, 127, 128, 131, 132, 135, 136, 139, 140, 143, 144,	D1, D2, D4, D0, D6, D3, D8, D5, D7, D10, D9, D12, D11, D14, D13, D15, D16, D18, D17, D20, D22, D19, D24, D21, D25, D23, D27, D26, D29, D28, D31, D30,	Data Bus
101	HLDA	Bus Hold Acknowledge

TABLE 2. 80386DX ABSOLUTE MAXIMUM RATINGS

PARAMETER	SYMBOL	MIN	MAX	UNIT
Supply Voltage with Respect to Ground	$V_{SS}$	-0.5	6.5	V
Voltage on other pins		-0.5	$V_{CC} + 0.5$	V
Thermal Impedance	$\Theta_{JC}$	--	1.79	°C/W
Operating Temperature Range (Ambient)	$T_A$	-55	125	°C
Storage Temperature Range (Ambient)	$T_S$	-65	150	°C

TABLE 3. DELTA LIMITS

PARAMETER	VARIATION
$I_{CC}$	±10% of specified value in Table 4
$I_{LI}$	±10% of specified value in Table 4
$I_{LO}$	±10% of specified value in Table 4

TABLE 4. 80386DX RECOMMENDED OPERATING CONDITIONS

PARAMETER	SYMBOL	MIN	MAX	UNIT
Digital Supply Voltage	$V_{CC}$	4.75	5.25	V
Input Low Voltage	$V_{IL}$	--	0.8	V
Input High Voltage	$V_{IH}$	2.0	--	V
CLK2 Input Low Voltage	$V_{ILC}$	--	0.8	V
CLK2 Input High Voltage	$V_{IHC}$	$V_{CC} - 0.8$	--	V
Operating Temperature Range	$T_A$	-55	+125	°C

TABLE 5. 80386DX DC ELECTRICAL CHARACTERISTICS

( $V_{CC} = +5V \pm 5\%$ ;  $T_A = -55^\circ C$  TO  $+125^\circ C$ , UNLESS OTHERWISE SPECIFIED)

PARAMETER	SYMBOL	CONDITION	MIN	MAX	UNIT
Input Leakage Current	$I_{LI}$	All pins except $\overline{BS16}$ , $\overline{PEREQ}$ , $\overline{BUSY}$ , and $\overline{ERROR}$ $0V \leq V_{IN} \leq V_{CC}$	-15	+15	$\mu A$
Output Leakage Current	$I_{LO}$	$0.45V \leq V_{OUT} \leq V_{CC}$	-15	+15	$\mu A$
Output Low Voltage	$V_{OL}$	$I_{OL} = 4 \text{ mA}$ : A2 - A31, D0 - D31	--	0.45	V
		$I_{OL} = 5 \text{ mA}$ : BE0 - BE3, W/R, D/C, M/I/O, LOCK, ADS, HLDA	--	0.45	
Output High Voltage	$V_{OH}$	$I_{OH} = 1 \text{ mA}$ : A2 - A31, D0 - D31	2.4	--	V
		$I_{OH} = 0.9 \text{ mA}$ : BE0 - BE3, W/R, D/C, M/I/O, LOCK, ADS, HLDA	2.4	--	

TABLE 5. 80386DX DC ELECTRICAL CHARACTERISTICS

 $(V_{CC} = +5V \pm 5\%; T_A = -55^\circ C \text{ TO } +125^\circ C, \text{ UNLESS OTHERWISE SPECIFIED})$ 

PARAMETER	SYMBOL	CONDITION	MIN	MAX	UNIT
Power Supply Current	$I_{CC}$	CLK2 = 32 MHz with 16 MHz Processor	--	460	mA
		CLK2 = 32 MHz with 20 MHz Processor	--	550	
		CLK2 = 32 MHz with 25 MHz Processor	--	680	
Input Leakage Current	$I_{IH}$	PEREQ Pin <sup>1</sup>	--	200	$\mu A$
	$I_{IL}$	BS16, BUSY, ERROR Pins <sup>2</sup>	--	-400	$\mu A$
CLK2 Capacitance <sup>3</sup>	$C_{CLK}$	$F_C = 1 \text{ MHz}$	--	20	pF
Input or I/O Capacitance <sup>1</sup>	$C_{IN}$	$F_C = 1 \text{ MHz}$	--	20	pF
Output Capacitance <sup>1</sup>	$C_{OUT}$	$F_C = 1 \text{ MHz}$	--	25	pF

1.  $V_{IH} = 2.4V$ . PEREQ input has an internal pulldown resistor.
2.  $V_{IL} = 0.45V$ . BS16, BUSY and ERROR inputs have an internal pulldown resistor.
3. Guaranteed by design.

TABLE 6. 80386DX AC ELECTRICAL CHARACTERISTICS

 $(V_{CC} = +5V \pm 10\%; V_{PP} = V_{SS}; T_A = -55^\circ C \text{ TO } +125^\circ C, \text{ UNLESS OTHERWISE SPECIFIED})$ 

PARAMETER	SYMBOL	CONDITION	MIN	MAX	UNIT	
Operating Frequency	--	Half of CLK2 Frequency			MHz	
			-16	4		16
			-20	4		20
			-25	4		25
CLK2 Period	$t_1$				ns	
			-16	31		125
			-20	25		125
			-25	20		125
CLK2 High Time	$t_{2a}$	at 2V			ns	
			-16	9		--
			-20	8		--
			-25	7		--
CLK2 High Time <sup>1</sup>	$t_{2b}$	at $(V_{CC} - 0.8V)$			ns	
			-16	5		--
			-20	5		--
			-25	4		--
CLK2 Low Time	$t_{3a}$	at 2V			ns	
			-16	9		--
			-20	8		--
			-25	7		--
CLK2 Low Time <sup>1</sup>	$t_{3b}$	at $(V_{CC} - 0.8V)$			ns	
			-16	7		--
			-20	6		--
			-25	5		--

TABLE 6. 80386DX AC ELECTRICAL CHARACTERISTICS  
 ( $V_{CC} = +5V \pm 10\%$ ;  $V_{PP} = V_{SS}$ ;  $T_A = -55^\circ C$  TO  $+125^\circ C$ , UNLESS OTHERWISE SPECIFIED)

PARAMETER	SYMBOL	CONDITION	MIN	MAX	UNIT
CLK2 Fall Time <sup>1</sup>	$t_4$	$(V_{CC} - 0.8V)$ to $0.8V$			ns
-16			--	8	
-20			--	8	
-25			--	7	
CLK2 Rise Time <sup>1</sup>	$t_5$	$0.8V$ to $(V_{CC} - 0.8V)$			ns
-16			--	8	
-20			--	8	
-25			--	7	
A2 - A31 Valid Delay	$t_6$	$C_L = 120pF$ ( $C_L = 50pF$ for 25 MHz)			ns
-16			4	36	
-20			4	30	
-25			4	21	
A2 - A31 Float Delay <sup>1, 2</sup>	$t_7$				ns
-16			4	40	
-20			4	32	
-25			4	30	
BE0 - BE3, LOCK Valid Delay	$t_8$	$C_L = 75pF$ ( $C_L = 50pF$ for 25 MHz)			ns
-16			4	36	
-20			4	30	
-25			4	24	
BE0 - BE3, LOCK Float Delay <sup>1, 2</sup>	$t_9$				ns
-16			4	40	
-20			4	32	
-25			4	30	
W/R, M/I $\bar{O}$ , D/C and ADS Valid Delay	$t_{10}$	$C_L = 75pF$ ( $C_L = 50pF$ for 25 MHz)			ns
-16			6	33	
-20			6	28	
-25			4	21	
W/R, M/I $\bar{O}$ , D/C and ADS Float Delay <sup>1, 2</sup>	$t_{11}$				ns
-16			6	35	
-20			6	30	
-25			4	30	
D0 - D31 Valid Delay	$t_{12}$	$C_L = 120pF$ ( $C_L = 50pF$ for 25 MHz)			ns
-16			4	48	
-20			4	38	
-25			7	27	
D0 - D31 Float Delay <sup>1, 2</sup>	$t_{13}$				ns
-16			4	35	
-20			4	27	
-25			4	22	
HLDA Valid Delay	$t_{14}$	$C_L = 75pF$ ( $C_L = 50pF$ for 25 MHz)			ns
-16			6	323	
-20			6	28	
-25			4	22	

TABLE 6. 80386DX AC ELECTRICAL CHARACTERISTICS  
 ( $V_{CC} = +5V \pm 10\%$ ;  $V_{PP} = V_{SS}$ ;  $T_A = -55^\circ C$  TO  $+125^\circ C$ , UNLESS OTHERWISE SPECIFIED)

PARAMETER	SYMBOL	CONDITION	MIN	MAX	UNIT
N/A Setup Time	$t_{15}$				ns
-16			11	--	
-20			9	--	
-25			7	--	
N/A Hold Time	$t_{16}$				ns
-16			14	--	
-20			14	--	
-25			3	--	
BS16 Setup Time	$t_{17}$				ns
-16			13	--	
-20			13	--	
-25			7	--	
BS16 Hold Time	$t_{18}$				ns
-16			21	--	
-20			21	--	
-25			3	--	
READY Setup Time	$t_{19}$				ns
-16			21	--	
-20			12	--	
-25			9	--	
READY Hold Time	$t_{20}$				ns
-16			4	--	
-20			4	--	
-25			4	--	
D0 - D31 Read Setup Delay	$t_{21}$				ns
-16			11	--	
-20			11	--	
-25			6	--	
D0 - D31 Read Hold Delay	$t_{22}$				ns
-16			6	--	
-20			6	--	
-25			5	--	
HOLD Setup Time	$t_{23}$				ns
-16			26	--	
-20			17	--	
-25			15	--	
HOLD Hold Time	$t_{24}$				ns
-16			5	--	
-20			5	--	
-25			3	--	
RESET Setup Time	$t_{25}$				ns
-16			10	--	
-20			10	--	
-25			10	--	

TABLE 6. 80386DX AC ELECTRICAL CHARACTERISTICS  
 ( $V_{CC} = +5V \pm 10\%$ ;  $V_{PP} = V_{SS}$ ;  $T_A = -55^\circ C$  TO  $+125^\circ C$ , UNLESS OTHERWISE SPECIFIED)

PARAMETER	SYMBOL	CONDITION	MIN	MAX	UNIT
RESET Hold Time -16 -20 -25	$t_{26}$		4 4 3	-- -- --	ns
NMI, INTR Setup Time <sup>3</sup> -16 -20 -25	$t_{27}$		16 16 6	-- -- --	ns
NMI, INTR Hold Time <sup>3</sup> -16 -20 -25	$t_{28}$		16 16 6	-- -- --	ns
REREQ, ERROR, BUSY Setup Time <sup>3</sup> -16 -20 -25	$t_{29}$		16 14 6	-- -- --	ns
REREQ, ERROR, BUSY Hold Time <sup>3</sup> -16 -20 -25	$t_{30}$		5 5 5	-- -- --	ns

1. Guaranteed by design.
2. Float condition occurs when maximum when output current becomes less than ILO in magnitude.
3. These inputs are allowed to be asynchronous to CLK2. The setup and hold specifications are given for testing purposes, to assure recognition within a specific CLK2 period.

FIGURE 1. AC TEST LOADS



$C_L = 120$  pF on A2-A31, D0-D31  
 $C_L = 75$  pF on BE0#-BE3#, W/R#, M/IO#, D/C#, ADS#,  
 LOCK#, HLDA  
 $C_L$  includes all parasitic capacitances.

FIGURE 2. CLK2 TIMING





FIGURE 3. INPUT SETUP AND HOLD TIME

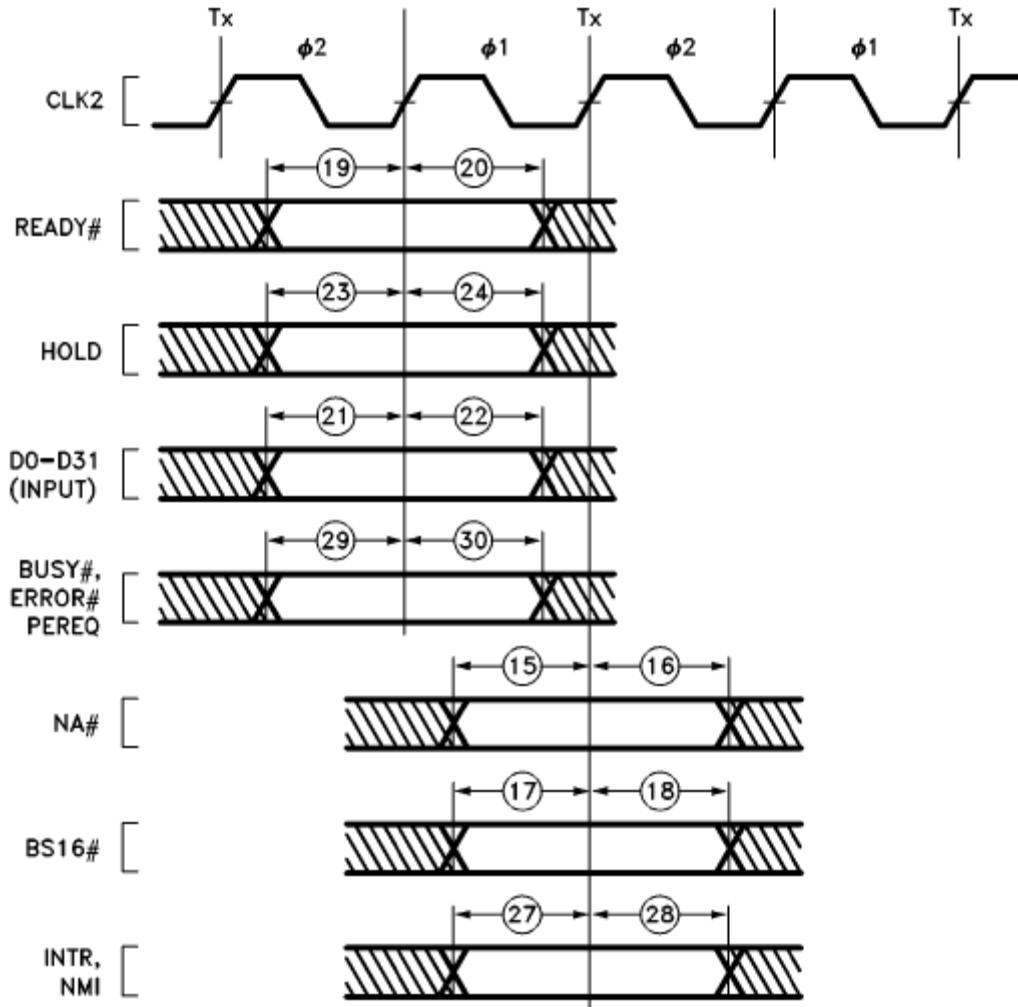

FIGURE 4. OUTPUT VALID DELAY TIMING

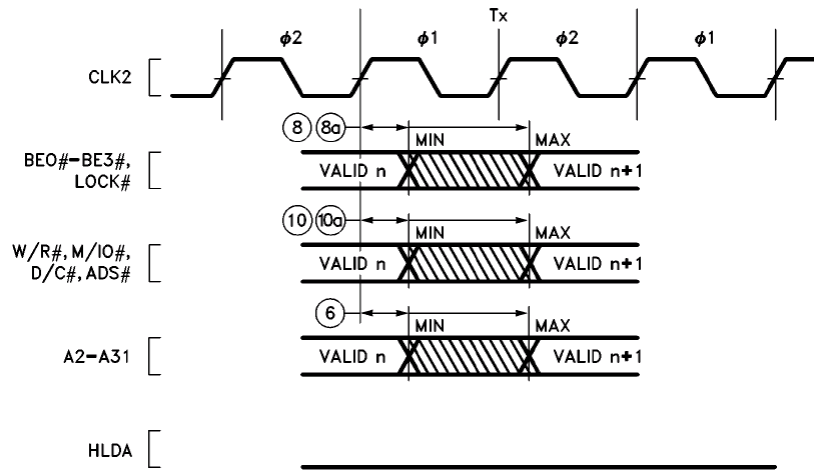

FIGURE 5. WRITE DATA VALID DELAY TIMING (25 MHz)

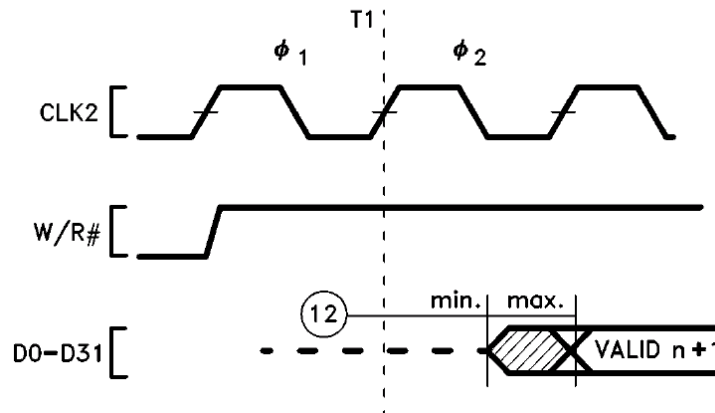

FIGURE 6. WRITE DATA HOLD TIMING (25 MHz)



FIGURE 7. WRITE DATA VALID DELAY TIMING (20 MHz)

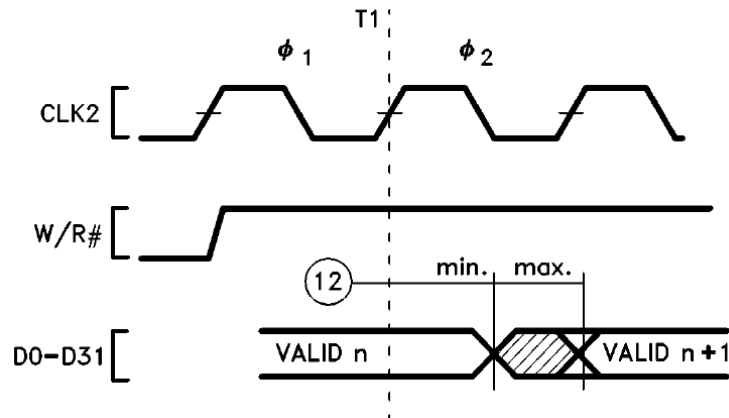

FIGURE 8. TYPICAL OUTPUT VALID DELAY VERSUS LOAD CAPACITANCE AT MAXIMUM OPERATING TEMPERATURE ( $C_L = 120$  pF)



**NOTE:**  
This graph will not be linear outside of the  $C_L$  range shown.

FIGURE 9. TYPICAL OUTPUT VALID DELAY VERSUS LOAD CAPACITANCE AT MAXIMUM OPERATING TEMPERATURE ( $C_L = 75$  pF)



**NOTE:**  
This graph will not be linear outside of the  $C_L$  range shown.

FIGURE 10. TYPICAL OUTPUT VALID DELAY VERSUS LOAD CAPACITANCE AT MAXIMUM OPERATING TEMPERATURE ( $C_L = 50$  pF)

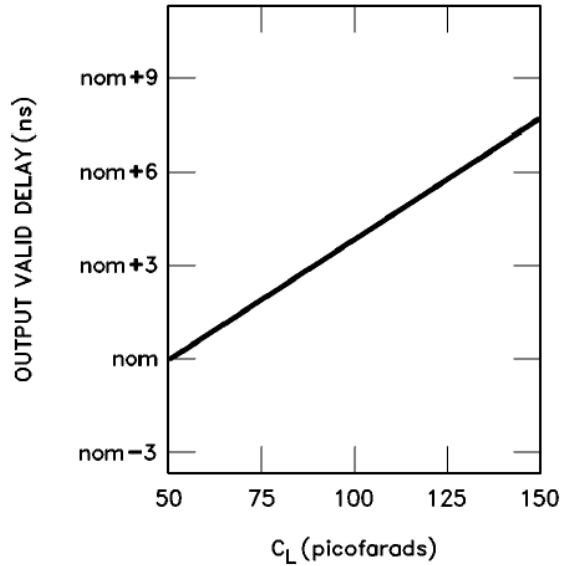

**NOTE:**  
This graph will not be linear outside of the  $C_L$  range shown.

FIGURE 11. TYPICAL OUTPUT RISE TIME VERSUS LOAD CAPACITANCE AT MAXIMUM OPERATING TEMPERATURE

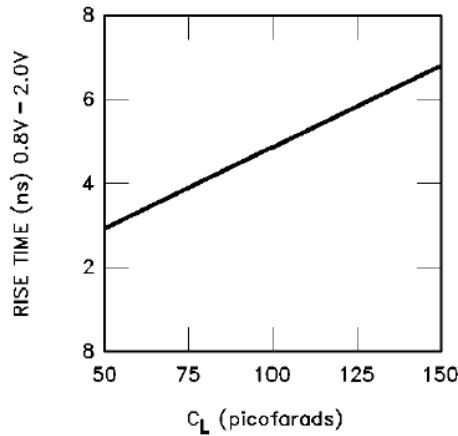

**NOTE:**  
This graph will not be linear outside of the  $C_L$  range shown.

FIGURE 12. OUTPUT FLOAT DELAY AND HLDA AND DELAY TIMING



FIGURE 13. RESET SETUP AND HOLD TIMING, AND INTERNAL PHASE

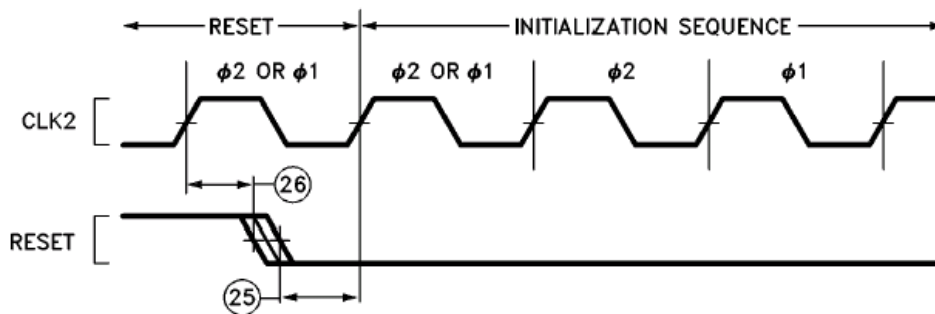

The second internal processor phase following RESET high-to-low transition (provided  $t_{25}$  and  $t_{26}$  are met) is  $\phi 2$ .



164-PIN RAD-PAK® QUAD FLAT PACKAGE

SYMBOL	DIMENSION		
	MIN	NOM	MAX
A	0.118	0.132	0.146
b	0.007	0.008	0.013
c	0.004	0.006	0.009
D	1.138	1.150	1.167
D1	1.000 BSC		
e	0.025 BSC		
S1	0.013	0.071	--
F1	0.890	0.895	0.900
F4	0.880	0.890	0.899
L	2.500	2.520	2.540
L1	2.485	2.500	2.505
L2	1.690	1.700	1.710
A1	0.078	0.090	0.102
N	164		

Q164-01

Note: All dimensions in inches

## Important Notice:

These data sheets are created using the chip manufacturer's published specifications. Maxwell Technologies verifies functionality by testing key parameters either by 100% testing, sample testing or characterization.

The specifications presented within these data sheets represent the latest and most accurate information available to date. However, these specifications are subject to change without notice and Maxwell Technologies assumes no responsibility for the use of this information.

Maxwell Technologies' products are not authorized for use as critical components in life support devices or systems without express written approval from Maxwell Technologies.

Any claim against Maxwell Technologies must be made within 90 days from the date of shipment from Maxwell Technologies. Maxwell Technologies' liability shall be limited to replacement of defective parts.



## Product Ordering Options

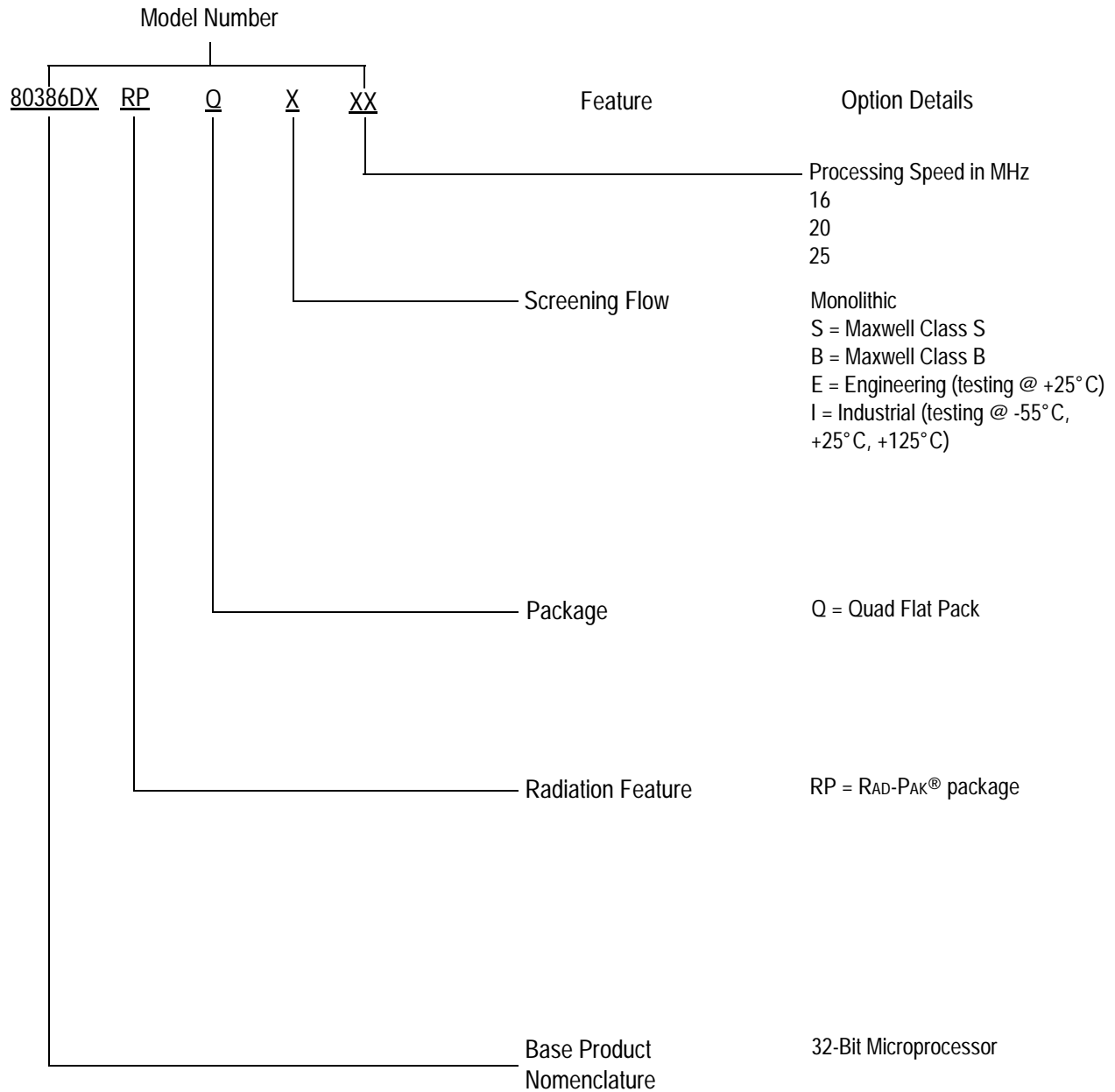

## **О компании**

ООО "ТрейдЭлектроникс" - это оперативные поставки широкого спектра электронных компонентов отечественного и импортного производства напрямую от производителей и с крупнейших мировых складов. Реализуемая нашей компанией продукция насчитывает более полумиллиона наименований.

Благодаря этому наша компания предлагает к поставке практически не ограниченный ассортимент компонентов как оптовыми, мелкооптовыми партиями, так и в розницу.

Наличие собственной эффективной системы логистики обеспечивает надежную поставку продукции по конкурентным ценам в точно указанные сроки.

Срок поставки со стоков в **Европе и Америке – от 3 до 14 дней.**

Срок поставки из **Азии – от 10 дней.**

Благодаря развитой сети поставщиков, помогаем в поиске и приобретении экзотичных или снятых с производства компонентов.

Предоставляем спец цены на элементы для создания инженерных сэмплов.

**Упорный труд, качественный результат дают нам право быть уверенными в себе и надежными для наших клиентов.**

### **Наша компания это:**

- Гарантия качества поставляемой продукции
- Широкий ассортимент
- Минимальные сроки поставок
- Техническая поддержка
- Подбор комплектации
- Индивидуальный подход
- Гибкое ценообразование

Наша организация особенно сильна в поставках модулей, микросхем, пассивных компонентов, ксайленсах (XC), EPF, EPM и силовой электроники.

Большой выбор предлагаемой продукции, различные виды оплаты и доставки, позволят Вам сэкономить время и получить максимум выгоды от сотрудничества с нами!

## Перечень производителей, продукцию которых мы поставляем на российский рынок



С удовольствием будем прорабатывать для Вас поставки всех необходимых компонентов по текущим запросам для скорейшего выявления групп элементов, по которым сотрудничество именно с нашей компанией будет для Вас максимально выгодным!

С уважением,

Менеджер отдела продаж ООО

«Трейд Электроникс»

Шишлаков Евгений

8 (495)668-30-28 доб 169

manager28@tradeelectronics.ru

<http://www.tradeelectronics.ru/>