

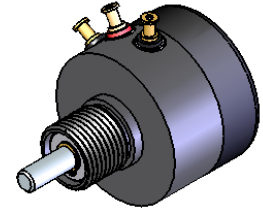

6209 SERIES

7/8 In. Dia. Bushing Mount
PRECISION POSITION
SENSORS



STANDARD PRODUCT OFFERING

SS&C PART NUMBER	RESISTANCE
6209-1000-030	1KΩ ±10%
6209-1002-030	5KΩ ±10%
6209-1003-030	10KΩ ±10%

MOUNTING HARDWARE FURNISHED

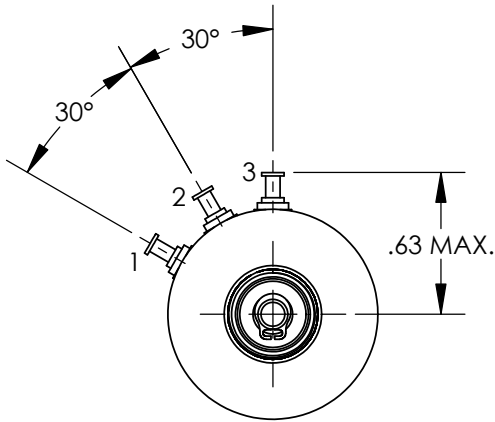

STANDARD MODEL ELECTRICAL CHARACTERISTICS

RESISTANCE:	1kΩ to 10kΩ ±10%
ACTIVE ELECTRICAL ANGLE:	340°
ELECTRICAL CONTINUITY ANGLE:	344° MIN.
INDEPENDENT LINEARITY:	±0.5%
END VOLTAGE:	0.5% MAX.
VOLTAGE RESOLUTION:	VIRTUALLY INFINITE
OUTPUT SMOOTHNESS:	0.1% MAX.
RESISTANCE TEMP. COEFFICIENT:	400PPM/°C MAX.
POWER RATING @ 70°C:	1.0 WATT MAX.
WIPER CONTACT CURRENT:	10 MilliAmps MAX.
DIELECTRIC STRENGTH:	750 VRMS @ 60Hz
INSULATION RESISTANCE:	100 MegΩ MIN. @ 500VDC

STANDARD MODEL MECHANICAL CHARACTERISTICS

MECHANICAL ROTATION:	CONTINUOUS
STARTING TORQUE:	0.25 Oz.-In. MAX.
RUNNING TORQUE:	0.20 Oz.-In. MAX.
TOTAL WEIGHT (1-GANG):	0.6 Oz. MAX.
PILOT RUNOUT:	0.001 In. TIR
SHAFT RUNOUT:	0.001 In. TIR
SHAFT END PLAY:	0.003 MAX.
SHAFT RADIAL PLAY:	0.001 In. TIR
LATERAL RUNOUT:	0.002 In. TIR

STANDARD MATERIALS OF CONSTRUCTION

HOUSING AND COVER:	ANODIZED ALUMINUM
SHAFT AND BALL BEARINGS:	STAINLESS STEEL
RESISTANCE ELEMENT:	CO-MOLDED CONDUCTIVE PLASTIC
ELECTRICAL CONTACTS:	MULTI-FINGER PRECIOUS METAL
SOLDER TERMINALS:	GOLD PLATED BRASS

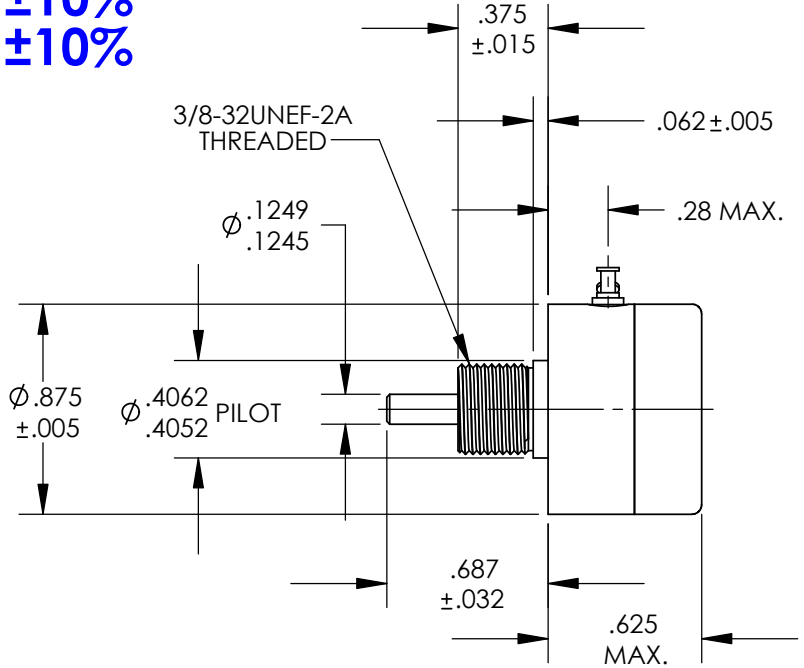

STANDARD ENVIRONMENTAL CHARACTERISTICS

OPERATING TEMP. RANGE:	-65°C To +125°C
ROTATIONAL OPERATING LIFE:	100 x 10 ⁶ REVOLUTIONS MIN.

SCHEMATIC DIAGRAM

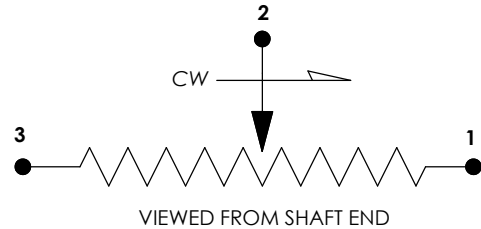

ALL OTHER GENERAL REQUIREMENTS IN ACCORDANCE WITH MIL-PRF-39023

CONTACT:

SPECTRUM SENSORS & CONTROLS, INC.
424 CROWN POINT CIRCLE, GRASS VALLEY, CA 95945
(800) 880-7730 (530) 273-4608 FAX: (530) 273-0769
E-MAIL: sales@specsensors.com

6209 SERIES

7/8 In. Dia. Bushing Mount PRECISION POSITION SENSORS

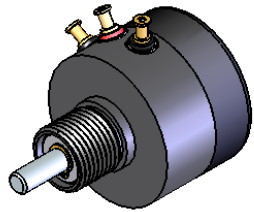
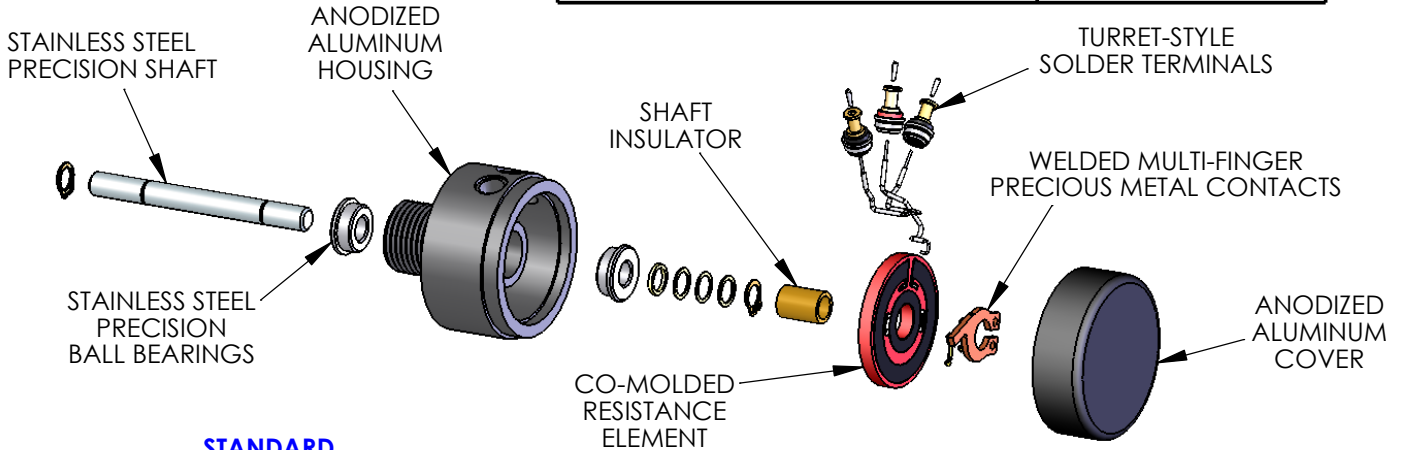
STANDARD ELECTRICAL CHARACTERISTICS

RESISTANCES ($\pm 10\%$):	1K Ω , 5K Ω , and 10k Ω
ACTIVE ELECTRICAL ANGLE:	340°
ELECTRICAL CONTINUITY ANGLE:	344° MIN.
INDEPENDENT LINEARITY:	$\pm 0.5\%$
END VOLTAGE:	0.5% MAX.
VOLTAGE RESOLUTION:	VIRTUALLY INFINITE
OUTPUT SMOOTHNESS:	0.1% MAX.
RESISTANCE TEMP. COEFFICIENT:	400PPM/°C MAX.
POWER RATING @ 70°C:	1.0 WATT MAX.
WIPER CONTACT CURRENT:	10 MilliAmps MAX.
DIELECTRIC STRENGTH:	750 VRMS @ 60Hz
INSULATION RESISTANCE:	100 Meg Ω MIN. @ 500VDC

STANDARD MECHANICAL CHARACTERISTICS

MECHANICAL ROTATION:	CONTINUOUS
STARTING TORQUE:	0.25 Oz.-In. MAX.
RUNNING TORQUE:	0.20 Oz.-In. MAX.
TOTAL WEIGHT (1-GANG):	0.6 Oz. MAX.
PILOT RUNOUT:	0.001 In. TIR
SHAFT RUNOUT:	0.001 In. TIR
SHAFT END PLAY:	0.003 MAX.
SHAFT RADIAL PLAY:	0.001 In. TIR
LATERAL RUNOUT:	0.002 In. TIR

STANDARD ENVIRONMENTAL CHARACTERISTICS

OPERATING TEMP. RANGE:	-65°C To +125°C
ROTATIONAL OPERATING LIFE:	100 x 10 ⁶ REVOLUTIONS MIN.

STANDARD MATERIALS OF CONSTRUCTION

HOUSING AND COVER:	ANODIZED ALUMINUM
SHAFT AND BALL BEARINGS:	STAINLESS STEEL
RESISTANCE ELEMENT:	CO-MOLDED CONDUCTIVE PLASTIC
ELECTRICAL CONTACTS:	MULTI-FINGER PRECIOUS METAL
SOLDER TERMINALS:	GOLD PLATED BRASS

ALL OTHER GENERAL REQUIREMENTS IN ACCORDANCE WITH MIL-PRF-39023

CONTACT: SPECTRUM SENSORS & CONTROLS, INC.
 424 CROWN POINT CIRCLE, GRASS VALLEY, CA 95945
 (800) 880-7730 (530) 273-4608 FAX: (530) 273-0769
 E-MAIL: sales@specsensors.com

AVAILABLE OPTIONS

CUSTOM RESISTANCE VALUES (500 Ω TO 50k Ω)
 AND TOLERANCES AS LOW AS $\pm 5\%$

SPECIAL LINEARITIES AS LOW AS 0.15%, ABSOLUTE
 (INDEXED) OR INDEPENDENT OVER SPECIFIED
 REGIONS.

ADDITIONAL TAPS, CURRENT OR VOLTAGE

CURRENT LIMIT RESISTORS AND OTHER INTERNAL
 CIRCUIT COMPONENTS (CAPS, DIODES, ETC.)

SPECIAL ELECTRICAL ANGLES UP TO 355° MAX.

WIRE LEADS OR CABLE IN PLACE OF TERMINALS

SPECIAL TRANSFER FUNCTIONS:
 NON-LINEAR OUTPUTS
 LOAD COMPENSATION
 TRIG, LOG, AND EXPONENTIAL OUTPUTS

MULTI-GANG CONSTRUCTION (UP TO 6) ON A
 COMMON SHAFT OR CONCENTRIC SHAFTING
 (ADD .320 LENGTH PER GANG).

SPECIAL SHAFT LENGTHS AND FEATURES SUCH AS
 REAR EXTENSIONS, FLATS, SLOTS, AND STEPS.

SPECIAL TORQUE OR DETENT REQUIREMENTS, AS
 LOW AS .015 Oz.-In. STARTING TORQUE.

SPECIAL MOUNTING DIMENSIONS OR FEATURES
 SUCH AS ANTI-ROTATION LOCATING PINS AND
 BUSHING FLATS OR SLOTS.

ROTATIONAL STOPS LIMITING SHAFT TRAVEL.

ANCILLIARY DEVICES SUCH AS SPRING RETURNS,
 CLUTCHES, BRAKES, AND SWITCHES.

SPECIAL ENVIRONMENTAL CAPABILITIES SUCH AS
 MOISTURE SEALS, HIGH SHOCK AND VIBRATION.

О компании

ООО "ТрейдЭлектроникс" - это оперативные поставки широкого спектра электронных компонентов отечественного и импортного производства напрямую от производителей и с крупнейших мировых складов. Реализуемая нашей компанией продукция насчитывает более полумиллиона наименований.

Благодаря этому наша компания предлагает к поставке практически не ограниченный ассортимент компонентов как оптовыми, мелкооптовыми партиями, так и в розницу.

Наличие собственной эффективной системы логистики обеспечивает надежную поставку продукции по конкурентным ценам в точно указанные сроки.

Срок поставки со стоков в **Европе и Америке – от 3 до 14 дней.**

Срок поставки из **Азии – от 10 дней.**

Благодаря развитой сети поставщиков, помогаем в поиске и приобретении экзотичных или снятых с производства компонентов.

Предоставляем спец цены на элементы для создания инженерных сэмплов.

Упорный труд, качественный результат дают нам право быть уверенными в себе и надежными для наших клиентов.

Наша компания это:

- Гарантия качества поставляемой продукции
- Широкий ассортимент
- Минимальные сроки поставок
- Техническая поддержка
- Подбор комплектации
- Индивидуальный подход
- Гибкое ценообразование

Наша организация особенно сильна в поставках модулей, микросхем, пассивных компонентов, ксайленсах (XC), EPF, EPM и силовой электроники.

Большой выбор предлагаемой продукции, различные виды оплаты и доставки, позволят Вам сэкономить время и получить максимум выгоды от сотрудничества с нами!

Перечень производителей, продукцию которых мы поставляем на российский рынок

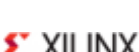

С удовольствием будем прорабатывать для Вас поставки всех необходимых компонентов по текущим запросам для скорейшего выявления групп элементов, по которым сотрудничество именно с нашей компанией будет для Вас максимально выгодным!

С уважением,

Менеджер отдела продаж ООО

«Трейд Электроникс»

Шишлаков Евгений

8 (495)668-30-28 доб 169

manager28@tradeelectronics.ru

<http://www.tradeelectronics.ru/>