



### APPLICATIONS

Wireless Network  
Telecom/Datacom  
Industry Control System  
Measurement Equipment  
Semiconductor Equipment

### FEATURES

- 30 WATTS MAXIMUM OUTPUT POWER
- OUTPUT CURRENT UP TO 6A
- STANDARD 2.0 X 1.6 X 0.4 INCH PACKAGE
- HIGH EFFICIENCY UP TO 90%
- 2:1 WIDE INPUT VOLTAGE RANGE
- SIX-SIDED CONTINUOUS SHIELD
- FIXED SWITCHING FREQUENCY
- OFFER SINGLE AND DUAL OUTPUT
- CE MARK MEETS 2006/95/EC, 93/68/EEC AND 2004/108/EC
- UL60950-1, EN60950-1 AND IEC60950-1 LICENSED
- ISO9001 CERTIFIED MANUFACTURING FACILITIES
- COMPLIANT TO RoHS EU DIRECTIVE 2002/95/EC

### DESCRIPTION

The FEC30 series offer 30 Watts of output power from a 2 x 1.6 x 0.4 inch package. The FEC30 series with 2:1 wide input voltage of 9-18VDC, 18-36VDC and 36-75VDC and features 1600VDC of isolation, short-circuit and over-voltage protection.

## TECHNICAL SPECIFICATION

All specifications are typical at nominal input, full load and 25°C otherwise noted

OUTPUT SPECIFICATIONS			
Output power			30 Watts, max.
Voltage accuracy	Full load and nominal Vin	Single/Dual	± 1%
Minimum load			0%
Voltage adjustability			± 10%
Line regulation	LL to HL at Full Load	Single Dual	± 0.2% ± 0.5%
Load regulation	No Load to Full Load	Single Dual	± 0.5% ± 1%
Cross regulation (Dual)	Asymmetrical load 25% / 100% FL		± 5%
Ripple and noise	20MHz bandwidth (Measured with a 0.1µF/50V MLCC)		See table
Temperature coefficient			±0.02% / °C, max.
Transient response recovery time	25% load step change		300µS
Over voltage protection Zener diode clamp	1.5V output		3.9VDC
	1.8V output		3.9VDC
	2.5V output		3.9VDC
	3.3V output		3.9VDC
	5V output		6.2VDC
	12V output		15VDC
Over load protection	15V output		18VDC
	% of FL at nominal input		150%, max.
Short circuit protection			Hiccup, automatics recovery
GENERAL SPECIFICATIONS			
Efficiency			See table
Isolation voltage	Input to Output Input (Output) to Case		1600VDC, min.
Isolation resistance			10 <sup>9</sup> ohms, min.
Isolation capacitance			1000pF, max.
Switching frequency			300KHz, typ.
Approvals and standard			IEC60950-1, UL60950-1, EN60950-1
Case material			Nickel-coated copper
Base material			FR4 PCB
Potting material			Epoxy (UL94-V0)
Dimensions			2.00 X 1.60 X 0.40 Inch (50.8 X 40.6 X 10.2 mm)
Weight			48g (1.69oz)
MTBF (Note 1)	BELLCORE TR-NWT-000332		1.316 x 10 <sup>6</sup> hrs
	MIL-HDBK-217F		3.465 x 10 <sup>5</sup> hrs

INPUT SPECIFICATIONS			
Input voltage range	12V nominal input		9 – 18VDC
	24V nominal input		18 – 36VDC
	48V nominal input		36 – 75VDC
Input filter			L-C type
Input surge voltage 100mS max	12V input		36VDC
	24V input		50VDC
	48V input		100VDC
Input reflected ripple current	Nominal Vin and full load		30mA p-p
Start up time	Nominal Vin and constant resistive load	Power up	25mS, typ.
		Remote ON/OFF	25mS, typ.
Start-up voltage	12V input		9VDC
	24V input		17.8VDC
	48V input		36VDC
Shutdown voltage	12V input		8VDC
	24V input		16VDC
	48V input		33VDC
Remote ON/OFF (Note 6) (Positive logic)	DC-DC ON	Open or 3.0V < Vr < 12V	
	DC-DC OFF	Short or 0V < Vr < 1.2V	
Input current of remote control pin	Nominal Vin		-0.5mA ~ 0.5mA
Remote off state input current	Nominal Vin		2.5mA

ENVIRONMENTAL SPECIFICATIONS		
Operating ambient temperature		-40°C ~ +85°C (with derating)
Maximum case temperature		100°C
Storage temperature range		-55°C ~ +105°C
Over temperature protection		115°C, typ
Thermal impedance (Note 7)	Nature convection	10°C/Watt
	Nature convection with heat-sink	8.24°C/Watt
Thermal shock		MIL-STD-810F
Vibration		MIL-STD-810F
Relative humidity		5% to 95% RH

EMC CHARACTERISTICS			
EMI (Note 8)	EN55022		Class A
ESD	EN61000-4-2	Air ± 8KV	Perf. Criteria B
		Contact ± 6KV	
Radiated immunity	EN61000-4-3	10 V/m	Perf. Criteria A
Fast transient (Note 9)	EN61000-4-4	± 2KV	Perf. Criteria B
Surge (Note 9)	EN61000-4-5	± 1KV	Perf. Criteria B
Conducted immunity	EN61000-4-6	10 Vr.m.s	Perf. Criteria A



Model Number	Input Range	Output Voltage	Output Current		Output <sup>(4)</sup> Ripple & Noise	Input Current		Eff <sup>(4)</sup> (%)	Capacitor <sup>(5)</sup> Load max
			Min. load	Full load		No load <sup>(3)</sup>	Full load <sup>(2)</sup>		
FEC30-12S1P5	9 – 18 VDC	1.5 VDC	0mA	6000mA	50mVp-p	100mA	1014mA	78	85800µF
FEC30-12S1P8	9 – 18 VDC	1.8 VDC	0mA	6000mA	50mVp-p	100mA	1169mA	81	65000µF
FEC30-12S2P5	9 – 18 VDC	2.5 VDC	0mA	6000mA	50mVp-p	110mA	1582mA	83	33000µF
FEC30-12S3P3	9 – 18 VDC	3.3 VDC	0mA	6000mA	50mVp-p	115mA	2037mA	85	19500µF
FEC30-12S05	9 – 18 VDC	5 VDC	0mA	6000mA	50mVp-p	95mA	3012mA	87	10200µF
FEC30-12S12	9 – 18 VDC	12 VDC	0mA	2500mA	75mVp-p	170mA	2976mA	88	3240µF
FEC30-12S15	9 – 18 VDC	15 VDC	0mA	2000mA	75mVp-p	210mA	2976mA	88	1100µF
FEC30-12D12	9 – 18 VDC	±12 VDC	0mA	±1250mA	100mVp-p	60mA	3012mA	87	±1020µF
FEC30-12D15	9 – 18 VDC	±15 VDC	0mA	±1000mA	100mVp-p	40mA	3012mA	87	±675µF
FEC30-24S1P5	18 – 36 VDC	1.5 VDC	0mA	6000mA	50mVp-p	50mA	493mA	80	85800µF
FEC30-24S1P8	18 – 36 VDC	1.8 VDC	0mA	6000mA	50mVp-p	35mA	580mA	82	65000µF
FEC30-24S2P5	18 – 36 VDC	2.5 VDC	0mA	6000mA	50mVp-p	45mA	780mA	84	33000µF
FEC30-24S3P3	18 – 36 VDC	3.3 VDC	0mA	6000mA	50mVp-p	50mA	1010mA	86	19500µF
FEC30-24S05	18 – 36 VDC	5 VDC	0mA	6000mA	50mVp-p	50mA	1490mA	88	10200µF
FEC30-24S12	18 – 36 VDC	12 VDC	0mA	2500mA	75mVp-p	80mA	1470mA	89	3300µF
FEC30-24S15	18 – 36 VDC	15 VDC	0mA	2000mA	75mVp-p	90mA	1470mA	89	1100µF
FEC30-24D12	18 – 36 VDC	±12 VDC	0mA	±1250mA	100mVp-p	30mA	1488mA	88	±1020µF
FEC30-24D15	18 – 36 VDC	±15 VDC	0mA	±1000mA	100mVp-p	30mA	1488mA	88	±675µF
FEC30-48S1P5	36 – 75 VDC	1.5 VDC	0mA	6000mA	50mVp-p	20mA	244mA	81	85800µF
FEC30-48S1P8	36 – 75 VDC	1.8 VDC	0mA	6000mA	50mVp-p	20mA	290mA	83	65000µF
FEC30-48S2P5	36 – 75 VDC	2.5 VDC	0mA	6000mA	50mVp-p	25mA	390mA	85	33000µF
FEC30-48S3P3	36 – 75 VDC	3.3 VDC	0mA	6000mA	50mVp-p	30mA	500mA	87	19500µF
FEC30-48S05	36 – 75 VDC	5 VDC	0mA	6000mA	50mVp-p	35mA	740mA	89	10200µF
FEC30-48S12	36 – 75 VDC	12 VDC	0mA	2500mA	75mVp-p	35mA	730mA	90	3300µF
FEC30-48S15	36 – 75 VDC	15 VDC	0mA	2000mA	75mVp-p	55mA	730mA	90	1100µF
FEC30-48D12	36 – 75 VDC	±12 VDC	0mA	±1250mA	100mVp-p	20mA	744mA	88	±1020µF
FEC30-48D15	36 – 75 VDC	±15 VDC	0mA	±1000mA	100mVp-p	20mA	744mA	88	±675µF

**Note**

1. BELLCORE TR-NWT-000332. Case 1: 50% Stress, Temperature at 40°C.  
MIL-HDBK-217F Notice2 @Ta=25 °C, Full load(Ground, Benign, controlled environment).
2. Maximum value at nominal input voltage and full load.
3. Typical value at nominal input voltage and no load.
4. Typical value at nominal input voltage and full load.
5. Test by minimum Vin and constant resistive load.
6. The ON/OFF control pin voltage is referenced to -Vin.
7. Heat sink is optional and P/N: 7G-0011C-F.
8. The FEC30 series can meet EN55022 Class A with parallel an external capacitor to the input pins.  
Recommend: 12Vin : 6.8µF/50V 1812 MLCC .  
24Vin : 6.8µF/50V 1812 MLCC .  
48Vin : 2.2µF/100V 1812 MLCC .
9. An external input filter capacitor is required if the module has to meet EN61000-4-4, EN61000-4-5.  
The filter capacitor Power Mate suggest: Nippon chemi-con KY series, 220 µ F/100V, ESR 48mΩ .

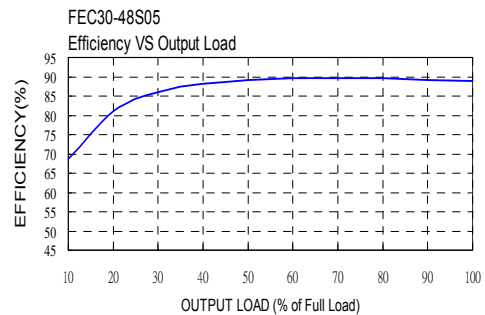
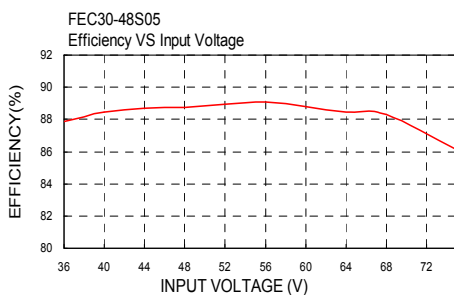
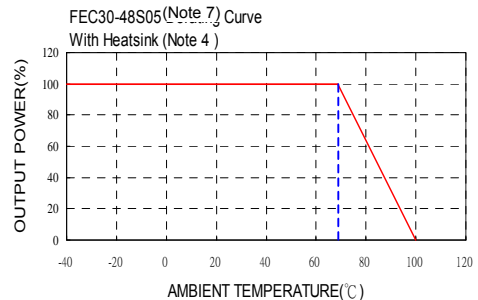
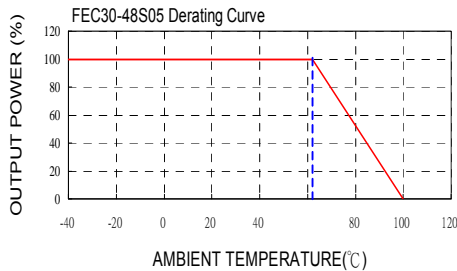

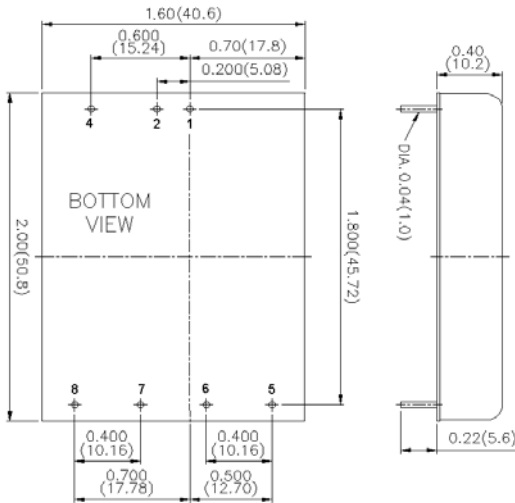

1. All dimensions in Inches (mm)  
Tolerance: X.XX±0.02 (X.X±0.5)  
X.XXX±0.01 (X.XX±0.25)
2. Pin pitch tolerance ±0.01(0.25)
3. Pin dimension tolerance ±0.004 (0.1)

PIN CONNECTION		
PIN	SINGLE	DUAL
1	+ INPUT	+ INPUT
2	- INPUT	- INPUT
4	CTRL	CTRL
5	NO PIN	+ OUTPUT
6	+ OUTPUT	COMMON
7	- OUTPUT	- OUTPUT
8	TRIM	TRIM

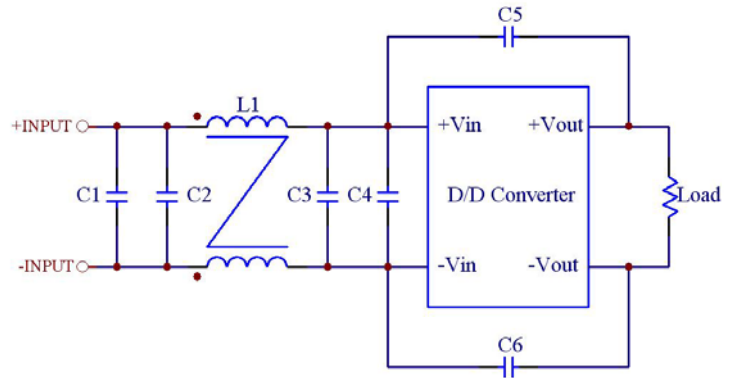
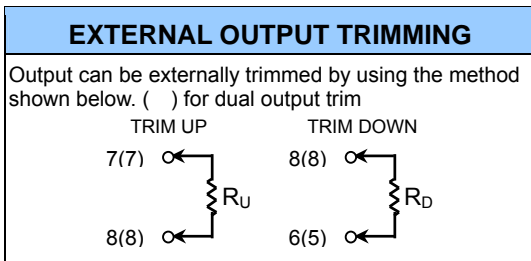

**Recommended Filter for EN55022 Class B Compliance**

The components used in the above figure, together with the manufacturers' part numbers for these components, are as follows:

	C1	C2	C3	C4	C5 & C6	L1
FEC30-12xxx	4.7µF/50V 1812 MLCC	N/A	4.7µF/50V 1812 MLCC	N/A	1000pF/2KV MLCC	450µH Common Choke PMT-048
FEC30-24xxx	6.8µF/50V 1812 MLCC	N/A	6.8µF/50V 1812 MLCC	N/A	1000pF/2KV MLCC	450µH Common Choke PMT-048
FEC30-48xxx	2.2µF/100V 1812 MLCC	2.2µF/100V 1812 MLCC	2.2µF/100V 1812 MLCC	2.2µF/100V 1812 MLCC	1000pF/2KV MLCC	450µH Common Choke PMT-048

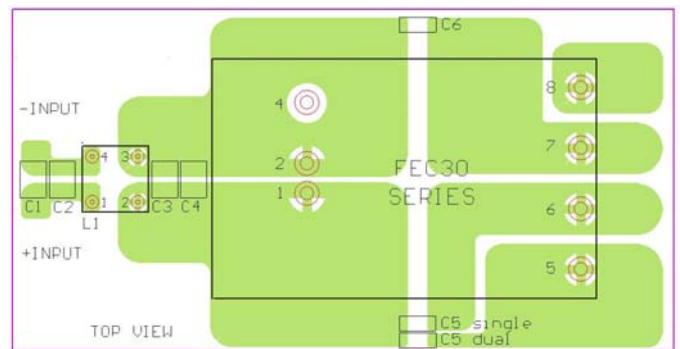

**Recommended EN55022 Class B Filter Circuit Layout**

## **О компании**

ООО "ТрейдЭлектроникс" - это оперативные поставки широкого спектра электронных компонентов отечественного и импортного производства напрямую от производителей и с крупнейших мировых складов. Реализуемая нашей компанией продукция насчитывает более полумиллиона наименований.

Благодаря этому наша компания предлагает к поставке практически не ограниченный ассортимент компонентов как оптовыми, мелкооптовыми партиями, так и в розницу.

Наличие собственной эффективной системы логистики обеспечивает надежную поставку продукции по конкурентным ценам в точно указанные сроки.

Срок поставки со стоков в **Европе и Америке – от 3 до 14 дней.**

Срок поставки из **Азии – от 10 дней.**

Благодаря развитой сети поставщиков, помогаем в поиске и приобретении экзотичных или снятых с производства компонентов.

Предоставляем спец цены на элементы для создания инженерных сэмплов.

**Упорный труд, качественный результат дают нам право быть уверенными в себе и надежными для наших клиентов.**

### **Наша компания это:**

- Гарантия качества поставляемой продукции
- Широкий ассортимент
- Минимальные сроки поставок
- Техническая поддержка
- Подбор комплектации
- Индивидуальный подход
- Гибкое ценообразование

Наша организация особенно сильна в поставках модулей, микросхем, пассивных компонентов, ксайленсах (XC), EPF, EPM и силовой электроники.

Большой выбор предлагаемой продукции, различные виды оплаты и доставки, позволят Вам сэкономить время и получить максимум выгоды от сотрудничества с нами!

## Перечень производителей, продукцию которых мы поставляем на российский рынок



С удовольствием будем прорабатывать для Вас поставки всех необходимых компонентов по текущим запросам для скорейшего выявления групп элементов, по которым сотрудничество именно с нашей компанией будет для Вас максимально выгодным!

С уважением,

Менеджер отдела продаж ООО

«Трейд Электроникс»

Шишлаков Евгений

8 (495)668-30-28 доб 169

manager28@tradeelectronics.ru

<http://www.tradeelectronics.ru/>