

## Features

- Low Forward Voltage Drop
- Fast Switching
- Ultra-Small Surface Mount Package
- PN Junction Guard Ring for Transient and ESD Protection
- **Qualified to AEC-Q101 Standards for High Reliability**
- **Totally Lead-Free & Fully RoHS Compliant (Notes 1 & 2)**
- **Halogen and Antimony Free. "Green" Device (Notes 3 & 4)**

## Mechanical Data

- Case: SOT323
- Case Material: Molded Plastic, "Green" Molding Compound, Note 5. UL Flammability Classification Rating 94V-0
- Moisture Sensitivity: Level 1 per J-STD-020
- Terminals: Matte Tin Finish annealed over Alloy 42 leadframe (Lead Free Plating). Solderable per MIL-STD-202, Method 208
- Polarity: See Diagrams Below
- Weight: 0.006 grams (approximate)

SOT323



Top View

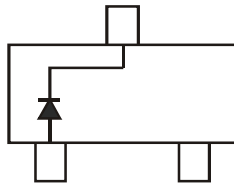

BAT54W-KL5

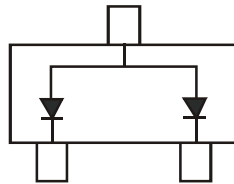

BAT54AW-KL6

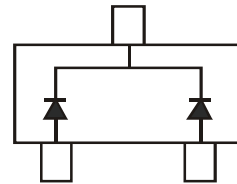

BAT54CW-KL7

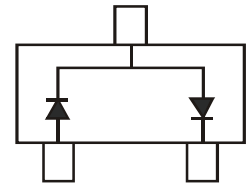

BAT54SW-KL8

## Ordering Information (Note 5)

| Part Number  | Case   | Packaging        |
|--------------|--------|------------------|
| BAT54W-7-F   | SOT323 | 3000/Tape & Reel |
| BAT54AW-7-F  | SOT323 | 3000/Tape & Reel |
| BAT54AWQ-7-F | SOT323 | 3000/Tape & Reel |
| BAT54CW-7-F  | SOT323 | 3000/Tape & Reel |
| BAT54SW-7-F  | SOT323 | 3000/Tape & Reel |
| BAT54SWQ-7-F | SOT323 | 3000/Tape & Reel |

- Notes:
1. No purposely added lead. Fully EU Directive 2002/95/EC (RoHS) & 2011/65/EU (RoHS 2) compliant.
  2. See <http://www.diodes.com> for more information about Diodes Incorporated's definitions of Halogen- and Antimony-free, "Green" and Lead-free.
  3. Halogen- and Antimony-free "Green" products are defined as those which contain <900ppm bromine, <900ppm chlorine (<1500ppm total Br + Cl) and <1000ppm antimony compounds.
  4. Product manufactured with Date Code 0627 (week 27, 2006) and newer are built with Green Molding Compound. Product manufactured prior to Date Code 0627 are built with Non-Green Molding Compound and may contain Halogens or Sb2O3 Fire Retardants.
  5. For packaging details, go to our website at <http://www.diodes.com>.

## Marking Information

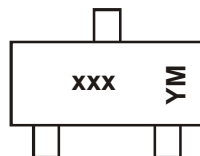

- xxx = Product Type Marking Code  
 KL5 = BAT54W  
 KL6 = BAT54AW  
 KL7 = BAT54CW  
 KL8 = BAT54SW  
 YM = Date Code Marking  
 Y = Year (ex: N = 2002)  
 M = Month (ex: 9 = September)

### Date Code Key

| Year  | 2000 | 2001 | 2002 | 2003 | 2004 | ... | 2010 | 2011 | 2012 | 2013 | 2014 | 2015 | 2016 | 2017 | 2018 |
|-------|------|------|------|------|------|-----|------|------|------|------|------|------|------|------|------|
| Code  | L    | M    | N    | P    | R    | ... | X    | Y    | Z    | A    | B    | C    | D    | E    | F    |
| Month | Jan  | Feb  | Mar  | Apr  | May  | Jun | Jul  | Aug  | Sep  | Oct  | Nov  | Dec  |      |      |      |
| Code  | 1    | 2    | 3    | 4    | 5    | 6   | 7    | 8    | 9    | O    | N    | D    |      |      |      |

**Maximum Ratings** (@T<sub>A</sub> = +25°C, unless otherwise specified.)

| Characteristic                           | Symbol           | Value | Unit |
|--|------------------|-------|------|
| Peak Repetitive Reverse Voltage          | V <sub>RRM</sub> | 30    | V    |
| Working Peak Reverse Voltage             | V <sub>RWM</sub> |       |      |
| DC Blocking Voltage                      | V <sub>R</sub>   |       |      |
| Forward Continuous Current (Note 6)      | I <sub>F</sub>   | 200   | mA   |
| Repetitive Peak Forward Current (Note 6) | I <sub>FRM</sub> | 300   | mA   |
| Forward Surge Current (Note 6)           | I <sub>FSM</sub> | 600   | mA   |

@ t < 1.0s

**Thermal Characteristics**

| Characteristic                                      | Symbol                            | Value       | Unit |
|---|-----------------------------------|-------------|------|
| Power Dissipation (Note 6)                          | P <sub>D</sub>                    | 200         | mW   |
| Thermal Resistance Junction to Ambient Air (Note 6) | R <sub>θJA</sub>                  | 625         | °C/W |
| Operating and Storage Temperature Range             | T <sub>J</sub> , T <sub>STG</sub> | -65 to +125 | °C   |

**Electrical Characteristics** (@T<sub>A</sub> = +25°C, unless otherwise specified.)

| Characteristic                     | Symbol             | Min | Typ | Max                              | Unit | Test Condition   |
|------------------------------------|--------------------|-----|-----|----------------------------------|------|--|
| Reverse Breakdown Voltage (Note 7) | V <sub>(BR)R</sub> | 30  | —   | —                                | V    | I <sub>R</sub> = 100µA   |
| Forward Voltage                    | V <sub>F</sub>     | —   | —   | 240<br>320<br>400<br>500<br>1000 | mV   | I <sub>F</sub> = 0.1mA<br>I <sub>F</sub> = 1mA<br>I <sub>F</sub> = 10mA<br>I <sub>F</sub> = 30mA<br>I <sub>F</sub> = 100mA |
| Reverse Leakage Current (Note 7)   | I <sub>R</sub>     | —   | —   | 2.0                              | µA   | V <sub>R</sub> = 25V   |
| Total Capacitance                  | C <sub>T</sub>     | —   | —   | 10                               | pF   | V <sub>R</sub> = 1.0V, f = 1.0MHz  |
| Reverse Recovery Time              | t <sub>rr</sub>    | —   | —   | 5.0                              | ns   | I <sub>F</sub> = 10mA through I <sub>R</sub> = 10mA to I <sub>R</sub> = 1.0mA, R <sub>L</sub> = 100Ω                       |

- Notes: 6. Mounted on FR-4 PC board with recommended pad layout which can be found on our website at <http://www.diodes.com>.  
7. Short duration pulse test used to minimize self-heating effect.

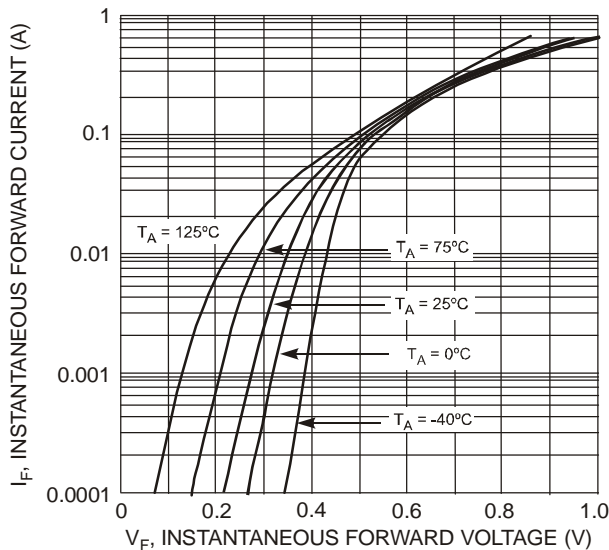

Fig. 1 Typical Forward Characteristics

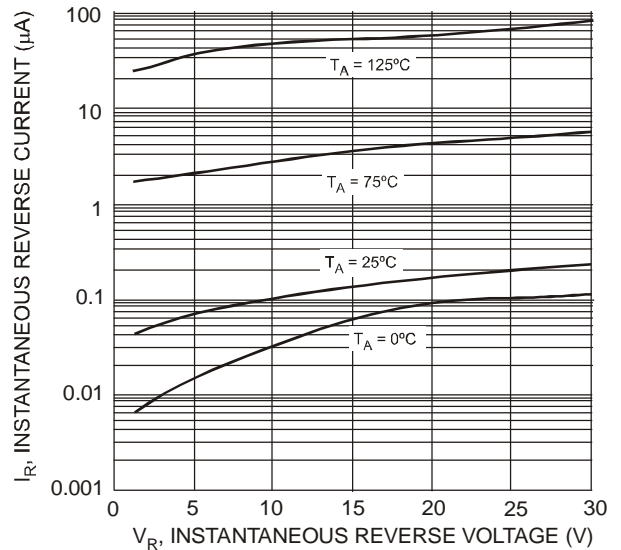

Fig. 2 Typical Reverse Characteristics

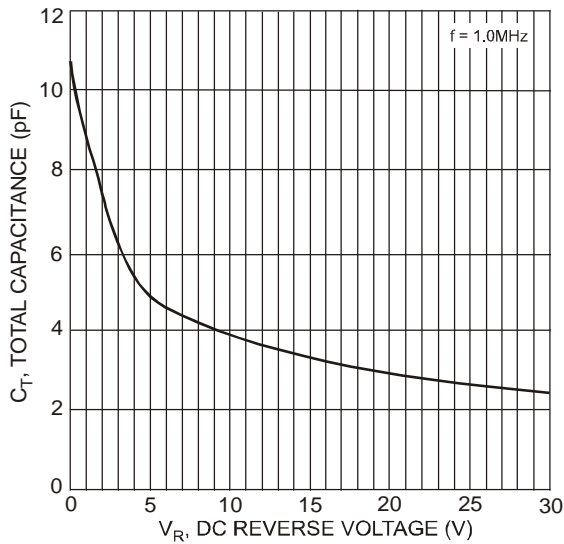

Fig. 3 Total Capacitance vs. Reverse Voltage

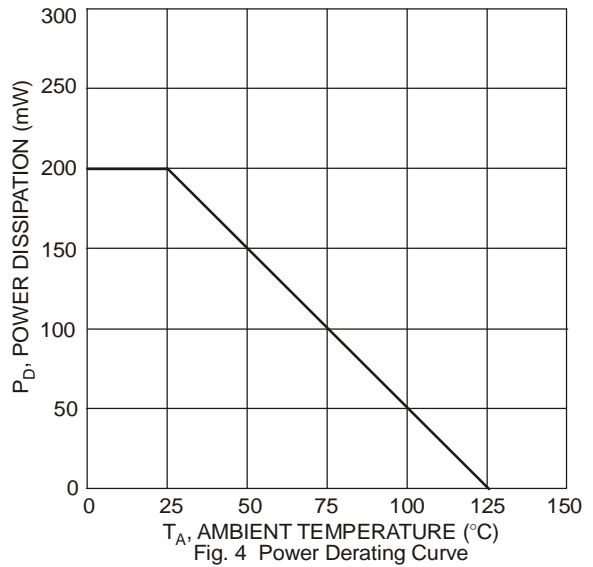
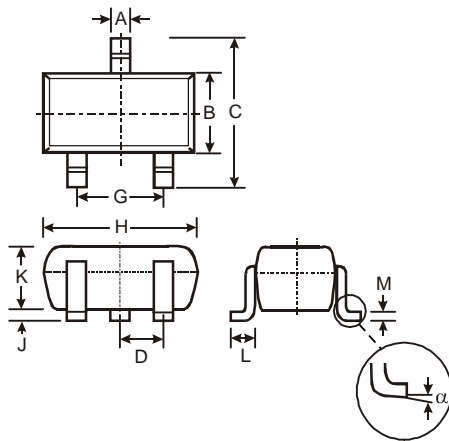

Fig. 4 Power Derating Curve

## Package Outline Dimensions

Please see AP02002 at <http://www.diodes.com/datasheets/ap02002.pdf> for latest version.



| SOT323               |      |      |      |
|----------------------|------|------|------|
| Dim                  | Min  | Max  | Typ  |
| A                    | 0.25 | 0.40 | 0.30 |
| B                    | 1.15 | 1.35 | 1.30 |
| C                    | 2.00 | 2.20 | 2.10 |
| D                    | -    | -    | 0.65 |
| G                    | 1.20 | 1.40 | 1.30 |
| H                    | 1.80 | 2.20 | 2.15 |
| J                    | 0.0  | 0.10 | 0.05 |
| K                    | 0.90 | 1.00 | 1.00 |
| L                    | 0.25 | 0.40 | 0.30 |
| M                    | 0.10 | 0.18 | 0.11 |
| $\alpha$             | 0°   | 8°   | -    |
| All Dimensions in mm |      |      |      |

## Suggested Pad Layout

Please see AP02001 at <http://www.diodes.com/datasheets/ap02001.pdf> for the latest version.

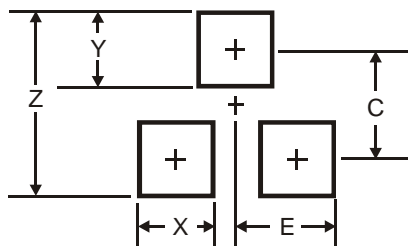

| Dimensions | Value (in mm) |
|------------|---------------|
| Z          | 2.8           |
| X          | 0.7           |
| Y          | 0.9           |
| C          | 1.9           |
| E          | 1.0           |

#### IMPORTANT NOTICE

DIODES INCORPORATED MAKES NO WARRANTY OF ANY KIND, EXPRESS OR IMPLIED, WITH REGARDS TO THIS DOCUMENT, INCLUDING, BUT NOT LIMITED TO, THE IMPLIED WARRANTIES OF MERCHANTABILITY AND FITNESS FOR A PARTICULAR PURPOSE (AND THEIR EQUIVALENTS UNDER THE LAWS OF ANY JURISDICTION).

Diodes Incorporated and its subsidiaries reserve the right to make modifications, enhancements, improvements, corrections or other changes without further notice to this document and any product described herein. Diodes Incorporated does not assume any liability arising out of the application or use of this document or any product described herein; neither does Diodes Incorporated convey any license under its patent or trademark rights, nor the rights of others. Any Customer or user of this document or products described herein in such applications shall assume all risks of such use and will agree to hold Diodes Incorporated and all the companies whose products are represented on Diodes Incorporated website, harmless against all damages.

Diodes Incorporated does not warrant or accept any liability whatsoever in respect of any products purchased through unauthorized sales channel. Should Customers purchase or use Diodes Incorporated products for any unintended or unauthorized application, Customers shall indemnify and hold Diodes Incorporated and its representatives harmless against all claims, damages, expenses, and attorney fees arising out of, directly or indirectly, any claim of personal injury or death associated with such unintended or unauthorized application.

Products described herein may be covered by one or more United States, international or foreign patents pending. Product names and markings noted herein may also be covered by one or more United States, international or foreign trademarks.

This document is written in English but may be translated into multiple languages for reference. Only the English version of this document is the final and determinative format released by Diodes Incorporated.

#### LIFE SUPPORT

Diodes Incorporated products are specifically not authorized for use as critical components in life support devices or systems without the express written approval of the Chief Executive Officer of Diodes Incorporated. As used herein:

A. Life support devices or systems are devices or systems which:

1. are intended to implant into the body, or
2. support or sustain life and whose failure to perform when properly used in accordance with instructions for use provided in the labeling can be reasonably expected to result in significant injury to the user.

B. A critical component is any component in a life support device or system whose failure to perform can be reasonably expected to cause the failure of the life support device or to affect its safety or effectiveness.

Customers represent that they have all necessary expertise in the safety and regulatory ramifications of their life support devices or systems, and acknowledge and agree that they are solely responsible for all legal, regulatory and safety-related requirements concerning their products and any use of Diodes Incorporated products in such safety-critical, life support devices or systems, notwithstanding any devices- or systems-related information or support that may be provided by Diodes Incorporated. Further, Customers must fully indemnify Diodes Incorporated and its representatives against any damages arising out of the use of Diodes Incorporated products in such safety-critical, life support devices or systems.

Copyright © 2012, Diodes Incorporated

[www.diodes.com](http://www.diodes.com)

## **О компании**

ООО "ТрейдЭлектроникс" - это оперативные поставки широкого спектра электронных компонентов отечественного и импортного производства напрямую от производителей и с крупнейших мировых складов. Реализуемая нашей компанией продукция насчитывает более полумиллиона наименований.

Благодаря этому наша компания предлагает к поставке практически не ограниченный ассортимент компонентов как оптовыми, мелкооптовыми партиями, так и в розницу.

Наличие собственной эффективной системы логистики обеспечивает надежную поставку продукции по конкурентным ценам в точно указанные сроки.

Срок поставки со стоков в **Европе и Америке – от 3 до 14 дней.**

Срок поставки из **Азии – от 10 дней.**

Благодаря развитой сети поставщиков, помогаем в поиске и приобретении экзотичных или снятых с производства компонентов.

Предоставляем спец цены на элементы для создания инженерных сэмплов.

**Упорный труд, качественный результат дают нам право быть уверенными в себе и надежными для наших клиентов.**

### **Наша компания это:**

- Гарантия качества поставляемой продукции
- Широкий ассортимент
- Минимальные сроки поставок
- Техническая поддержка
- Подбор комплектации
- Индивидуальный подход
- Гибкое ценообразование

Наша организация особенно сильна в поставках модулей, микросхем, пассивных компонентов, ксайленсах (XC), EPF, EPM и силовой электроники.

Большой выбор предлагаемой продукции, различные виды оплаты и доставки, позволят Вам сэкономить время и получить максимум выгоды от сотрудничества с нами!

## Перечень производителей, продукцию которых мы поставляем на российский рынок



С удовольствием будем прорабатывать для Вас поставки всех необходимых компонентов по текущим запросам для скорейшего выявления групп элементов, по которым сотрудничество именно с нашей компанией будет для Вас максимально выгодным!

С уважением,

Менеджер отдела продаж ООО

«Трейд Электроникс»

Шишлаков Евгений

8 (495)668-30-28 доб 169

manager28@tradeelectronics.ru

<http://www.tradeelectronics.ru/>