

FDD15 SERIES

DC - DC CONVERTER
10 ~ 15W SINGLE & DUAL OUTPUT



FEATURES

- LOW COST
- 2:1 WIDE INPUT RANGE
- I/O ISOLATION
- LC INPUT FILTER
- SHORT CIRCUIT PROTECTION
- HIGH PERFORMANCE
- 2 YEARS WARRANTY

MODEL LIST

MODEL NO.	INPUT VOLTAGE	INPUT CURRENT (typ.)	OUTPUT WATTAGE	OUTPUT VOLTAGE	OUTPUT CURRENT	EFF. (min.)	EFF. (typ.)	CAPACITOR LOAD (max.)
-----------	---------------	----------------------	----------------	----------------	----------------	-------------	-------------	-----------------------

Single Output Models

FDD15 - 03S1	9~18 VDC	1.1 A	10 WATTS	+ 3.3 VDC	3000 mA	75%	77%	4700 μ F
FDD15 - 05S1	9~18 VDC	1.08 A	10 WATTS	+ 5 VDC	2000 mA	75%	77%	4700 μ F
FDD15 - 12S1	9~18 VDC	1.07 A	10 WATTS	+ 12 VDC	834 mA	75%	77%	3500 μ F
FDD15 - 15S1	9~18 VDC	1.07 A	10 WATTS	+ 15 VDC	667 mA	76%	78%	3500 μ F
FDD15 - 03S2	18~36 VDC	0.54 A	10 WATTS	+ 3.3 VDC	3000 mA	75%	77%	4700 μ F
FDD15 - 05S2	18~36 VDC	0.79 A	15 WATTS	+ 5 VDC	3000 mA	78%	80%	4700 μ F
FDD15 - 12S2	18~36 VDC	0.78 A	15 WATTS	+ 12 VDC	1250 mA	79%	81%	3500 μ F
FDD15 - 15S2	18~36 VDC	0.77 A	15 WATTS	+ 15 VDC	1000 mA	80%	82%	3500 μ F
FDD15 - 03S3	36~72 VDC	0.27 A	10 WATTS	+ 3.3 VDC	3000 mA	74%	76%	4700 μ F
FDD15 - 05S3	36~72 VDC	0.39 A	15 WATTS	+ 5 VDC	3000 mA	78%	80%	4700 μ F
FDD15 - 12S3	36~72 VDC	0.39 A	15 WATTS	+ 12 VDC	1250 mA	79%	81%	3500 μ F
FDD15 - 15S3	36~72 VDC	0.39 A	15 WATTS	+ 15 VDC	1000 mA	79%	81%	3500 μ F

Dual Output Models

FDD15 - 12D1	9~18 VDC	1.12 A	10 WATTS	\pm 12 VDC	\pm 417 mA	73%	76%	\pm 1000 μ F
FDD15 - 15D1	9~18 VDC	1.09 A	10 WATTS	\pm 15 VDC	\pm 334 mA	75%	78%	\pm 1000 μ F
FDD15 - 12D2	18~36 VDC	0.77 A	15 WATTS	\pm 12 VDC	\pm 625 mA	80%	83%	\pm 1000 μ F
FDD15 - 15D2	18~36 VDC	0.77 A	15 WATTS	\pm 15 VDC	\pm 500 mA	80%	83%	\pm 1000 μ F
FDD15 - 12D3	36~72 VDC	0.38 A	15 WATTS	\pm 12 VDC	\pm 625 mA	80%	83%	\pm 1000 μ F
FDD15 - 15D3	36~72 VDC	0.38 A	15 WATTS	\pm 15 VDC	\pm 500 mA	80%	83%	\pm 1000 μ F

SPECIFICATION

All Specifications Typical At Nominal Line, Full Load, 25°C Unless Otherwise Noticed

GENERAL

Characteristics	Conditions	min.	typ.	max.	unit
Switching frequency	Vi nom, Io nom		200		KHz
Isolation voltage	Input - Output	1500			VDC
Isolation resistance	Input - Output, @ 500VDC	100			MΩ
Isolation capacitance	100KHz / 1V			1000	PF
Ambient temperature	Operating at Vi nom, Io nom	-10		+ 51	°C
Case temperature	Operating at Vi nom, Io nom			+ 85	°C
Derating	Vi nom	See derating curve			
Storage temperature	Non operational	-25		+ 100	°C
Relative humidity	Vi nom, Io nom	20		95	% RH
Temperature coefficient	Vi nom, Io min			± 0.02	% / °C
Dimension		L50.8 x W50.8 x H12.0			mm
MTBF	Bellcore issue 6@40°C, GB		889000		Hours
Cooling	Free air convection				

INPUT SPECIFICATIONS

Characteristics	Conditions	min.	typ.	max.	unit
Input voltage range	Ta min ... Ta max, Io nom	9	12	18	VDC
		18	24	36	VDC
		36	48	72	VDC
No load input current	Vi nom, Io = 0	12V models		30	mA
		24V models		25	mA
		48V models		15	mA
Input voltage w/o damage	Io nom	12V models		20	VDC
		24V models		40	VDC
		48V models		75	VDC
Startup voltage	Io nom	12V models	8.5		VDC
		24V models	15		VDC
		48V models	35		VDC
Input filter	Pi type				

OUTPUT SPECIFICATIONS

Characteristics	Conditions	min.	typ.	max.	unit
Output voltage accuracy	Vi nom, Io nom			± 2	%
Minimum load	Vi nom single output models	0			%
	Vi nom dual output models (each output)	20			%
Line regulation	Io nom, Vi min ... Vi max			± 1	%
Load regulation	Vi nom, Io 0 ... Io nom, single output models			± 2	%
	Vi nom, Io min ... Io nom, dual output models			± 5	%
Cross regulation (Dual model)	Aymmetrical load 20% - 100% FL			± 5	%
Startup time	Vi nom, Io nom			1000	ms
Transient recovery time	Vi nom, I ~ 0.5 Io nom			500	μs
Ripple & noise	Vi nom, Io nom, 3.3V model			100	mV
	Vi nom, Io nom, BW = 20MHz 5V, 12V, 15V & dual			Vout x ± 1%	mV
Efficiency	Vi nom, Io nom, Po / Pi	Up to 83%, See model list and efficiency curve			

CONTROL AND PROTECTION

Input reversed	Shunt diode built in, external fuse recommended (12Vin : 1.5A, 24Vin : 1 A, 48Vin : 0.5 A)
Output short circuit	Current limited (Auto-recovery)
Rated over load protection	110%min....140%max

PHYSICAL CHARACTERISTICS

Case size	50.8 x 50.8 x 12.0 mm (2 x 2 x 0.47 inches)
Case material	Plastic base / Metal case
Weight	70 g
Patting material	Epoxy

MECHANISM & PIN CONFIGURATION

mm [inch]

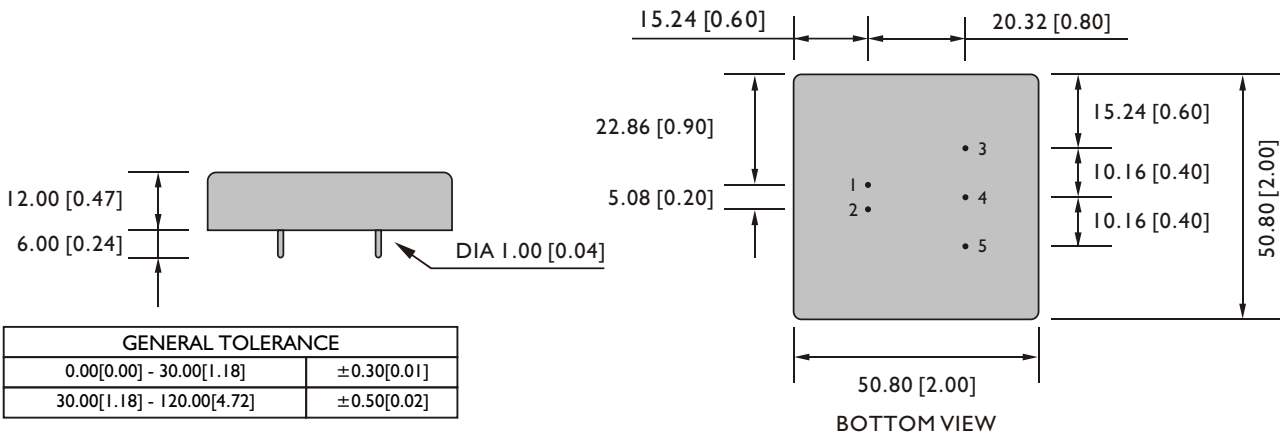

PIN ASSIGNMENT

GENERAL

PIN NO.	1	2	3	4	5
SINGLE	Vi+	Vi-	Vo+	NO PIN	Vo-
DUAL	Vi+	Vi-	Vo+	com	Vo-

CIRCUIT SCHEMATIC

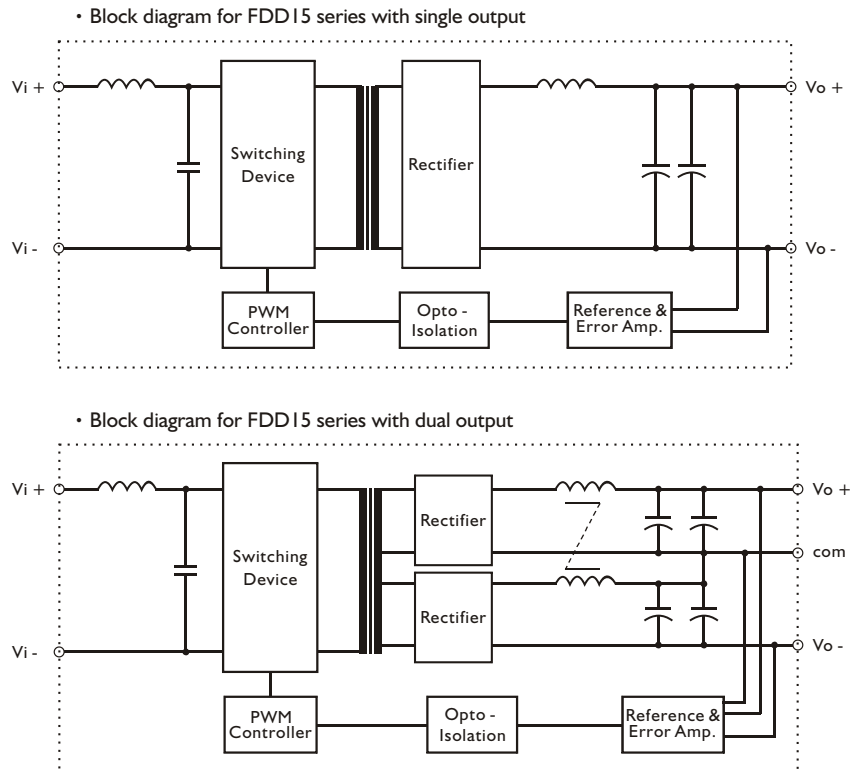

RECOMMENDED CIRCUIT

- Recommended filter for EN55022 Class B compliance

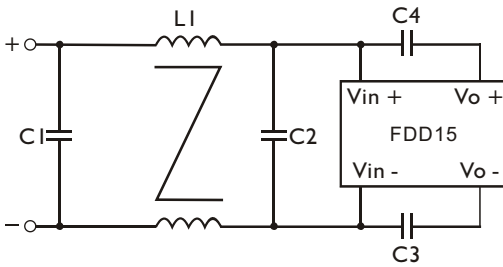

- The components used in the above figure, together with the manufacturer part numbers for these components, are as follows.

	C1	C2	C3	C4	L1
FDD15-XXX1	6.8 μ F / 50V MLCC	4.7 μ F / 50V MLCC	1nF / 2KV MLCC	1nF / 2KV MLCC	0.5mH Common Choke
FDD15-XXX2	4.7 μ F / 50V MLCC	4.7 μ F / 50V MLCC	1nF / 2KV MLCC	1nF / 2KV MLCC	0.5mH Common Choke
FDD15-XXX3	4.7 μ F / 100V MLCC	4.7 μ F / 100V MLCC	1nF / 2KV MLCC	1nF / 2KV MLCC	0.5mH Common Choke

- Recommended EN 55022 Class B filter circuit layout.

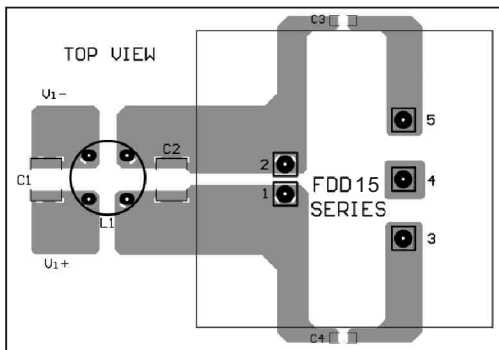

DERATING AND EFFICIENCY CURVE

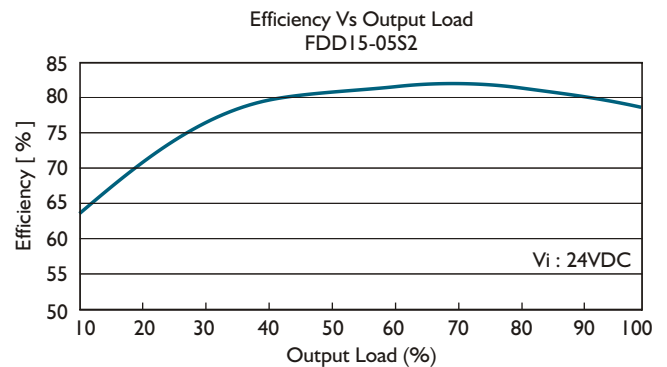
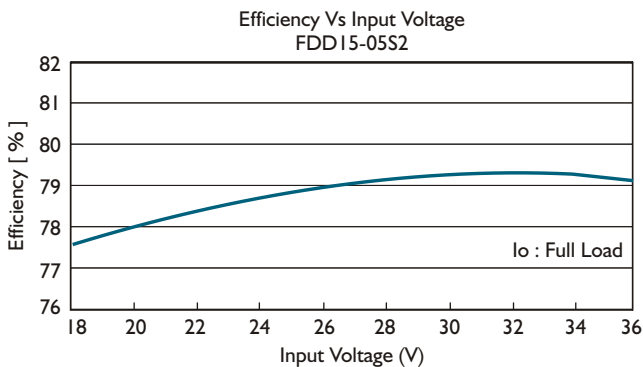
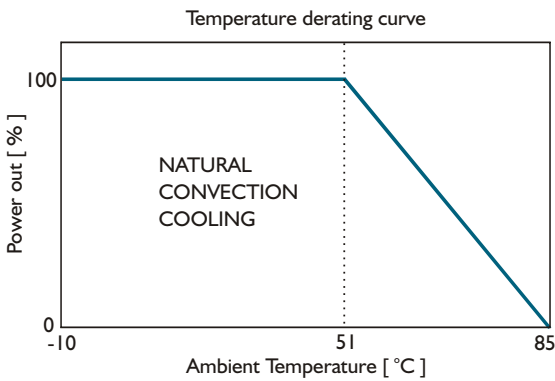

FDD15 SERIES

DC - DC CONVERTER
10 ~ 15W TRIPLE OUTPUT



FEATURES

- LOW COST
- 2:1 WIDE INPUT RANGE
- I/O ISOLATION
- LC INPUT FILTER
- SHORT CIRCUIT PROTECTION
- HIGH PERFORMANCE
- 2 YEARS WARRANTY

MODEL LIST

MODEL NO.	INPUT VOLTAGE	INPUT CURRENT (typ.)	OUTPUT WATTAGE	OUTPUT VOLTAGE	OUTPUT CURRENT	EFF. (min.)	EFF. (typ.)	CAPACITOR LOAD (max.)
Triple Output Models								
FDD15 - 0512T1	9~18 VDC	1.07 A	10 WATTS	+5 / ±12 VDC	1.5A / ± 0.12A	77%	79%	4700 μ F / ±2200 μ F
FDD15 - 0515T1	9~18 VDC	1.07 A	10 WATTS	+5 / ±15 VDC	1.5A / ± 0.1 A	77%	79%	4700 μ F / ±2200 μ F
FDD15 - 0512T2	18~36 VDC	0.76 A	15 WATTS	+5 / ±12 VDC	2 A / ± 0.2 A	80%	82%	4700 μ F / ±2200 μ F
FDD15 - 0515T2	18~36 VDC	0.76 A	15 WATTS	+5 / ±15 VDC	2 A / ± 0.16A	80%	82%	4700 μ F / ±2200 μ F
FDD15 - 0512T3	36~72 VDC	0.38 A	15 WATTS	+5 / ±12 VDC	2 A / ± 0.2 A	80%	82%	4700 μ F / ±2200 μ F
FDD15 - 0515T3	36~72 VDC	0.38 A	15 WATTS	+5 / ±15 VDC	2 A / ± 0.16A	80%	82%	4700 μ F / ±2200 μ F

SPECIFICATION

All Specifications Typical At Nominal Line, Full Load, 25°C Unless Otherwise Noticed

GENERAL

Characteristics	Conditions	min.	typ.	max.	unit
Switching frequency	Vi nom, Io nom		180		KHz
Isolation voltage	Input - Output	1500			VDC
Isolation resistance	Input - Output, @ 500VDC	100			MΩ
Isolation capacitance	100KHz / 1V			1000	PF
Ambient temperature	Operating at Vi nom, Io nom	-10		+ 51	°C
Case temperature	Operating at Vi nom, Io nom			+100	°C
Derating	Vi nom	See derating curve			
Storage temperature	Non operational	-40		+100	°C
Relative humidity	Vi nom, Io nom	20		95	% RH
Temperature coefficient	Vi nom, Io min			± 0.02	% / °C
Dimension		L50.8 x W50.8 x H12.0			mm
MTBF	Belcore issue 6@40°C, GB		720000		Hours
Cooling	Free air convection				

INPUT SPECIFICATIONS

Characteristics	Conditions	min.	typ.	max.	unit
Input voltage range	Ta min ... Ta max, Io nom	9	12	18	VDC
		18	24	36	VDC
		36	48	72	VDC
No load input current	Vi nom, Io = 0	12V models		30	mA
		24V models		25	mA
		48V models		15	mA
Input voltage w/o damage	Io nom	12V models		20	VDC
		24V models		40	VDC
		48V models		75	VDC
Startup voltage	Io nom	12V models	8.5		VDC
		24V models	13.6		VDC
		48V models	24		VDC
Input filter	Pi type				

OUTPUT SPECIFICATIONS

Characteristics	Conditions	min.	typ.	max.	unit
Output voltage accuracy	Vi nom, Io nom	+ 5V		± 2	%
		±12V or ±15V		± 6	%
Minimum load	Vi nom	+ 5V	10		%
		±12V or ±15V	20		%
Line regulation	Vi min ...Vi max, Io nom	+ 5V		± 2	%
		±12V or ±15V		± 6	%
Load regulation	Vi nom, Io min ...Io nom	+ 5V		± 2	%
		±12V or ±15V		± 6	%
Cross regulation	Aymmetrical load 20% - 100% FL			± 6	%
Startup time	Vi nom, Io nom			30	ms
Transient recovery time	Vi nom, I ~ 0.5 Io nom			500	μs
Ripple & noise	Vi nom, Io nom, BW = 20MHz			Vout x ± 1%	mV
Efficiency	Vi nom, Io nom, Po / Pi	Up to 82%, See model list and efficiency curve			

CONTROL AND PROTECTION

Remote ON / OFF	ON : opened or 8 ~ 10VDC applied, reference to input GND OFF : -0.3 ~ 2VDC applied, reference to input GND
Input reversed	Shunt diode built in, external fuse recommended (12Vin : 1.5A, 24Vin : 1A, 48Vin : 0.5A)
Output short circuit	Current limited (Auto-recovery)
Rated over load protection	I 10%min.... I 40%max

PHYSICAL CHARACTERISTICS

Case size	50.8 x 50.8 x 12.0 mm (2 x 2 x 0.47 inches)
Case material	Plastic base / Metal case
Weight	70 g
Patting material	Epoxy

MECHANISM & PIN CONFIGURATION

mm [inch]

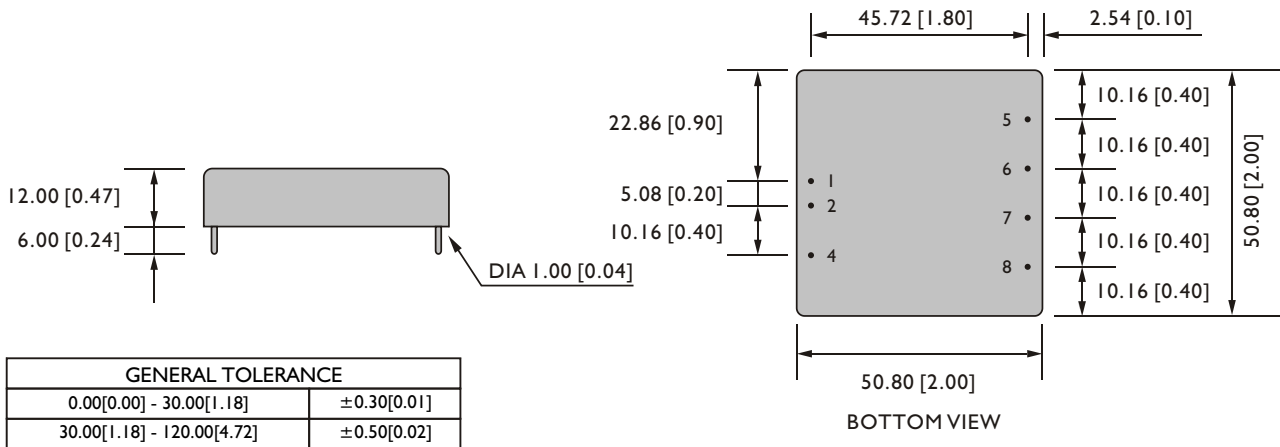

PIN ASSIGNMENT

GENERAL

PIN NO.	1	2	4	5	6	7	8
TRIPLE	Vi+	Vi-	ON/OFF	Vo2 (+ OUT)	Vo1 (+ 5V)	com	Vo3 (- OUT)

CIRCUIT SCHEMATIC

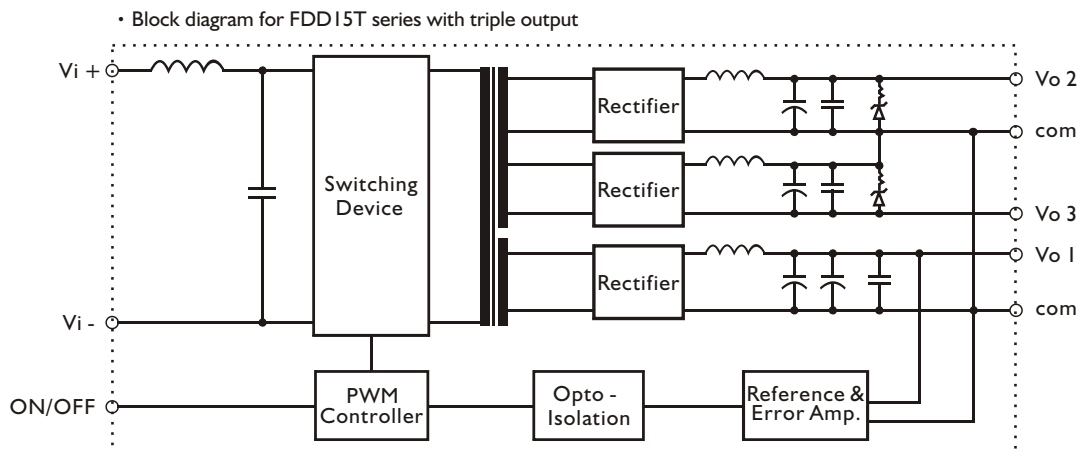

RECOMMENDED CIRCUIT

- Recommended filter for EN55022 Class B compliance

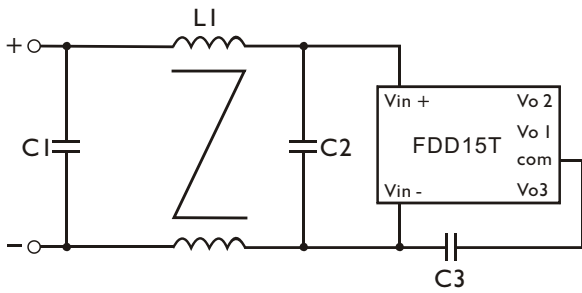

- The components used in the above figure, together with the manufacturer part numbers for these components, are as follows.

	C1	C2	C3	L1
FDD15-XXXXT1	3.3 μ F / 50V MLCC	3.3 μ F / 50V MLCC	InF / 2KV MLCC	0.5mH Common Choke
FDD15-XXXXT2	3.3 μ F / 50V MLCC	3.3 μ F / 50V MLCC	InF / 2KV MLCC	0.5mH Common Choke
FDD15-XXXXT3	2.2 μ F / 100V MLCC	2.2 μ F / 100V MLCC	InF / 2KV MLCC	0.5mH Common Choke

- Recommended EN 55022 Class B filter circuit layout.

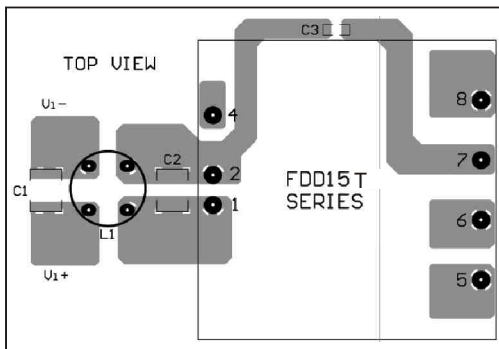

DERATING AND EFFICIENCY CURVE

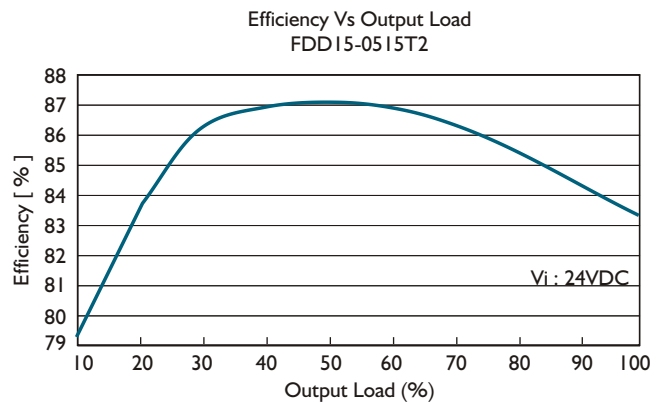
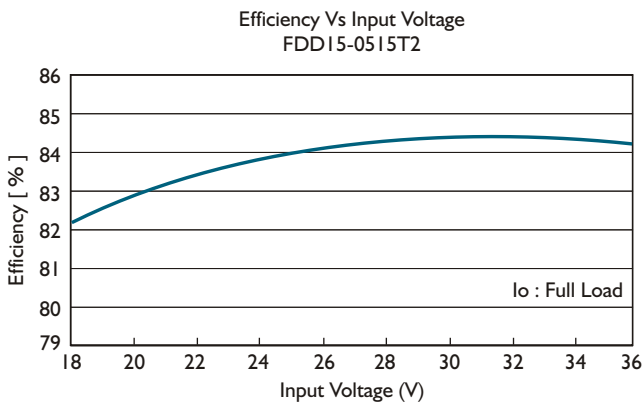
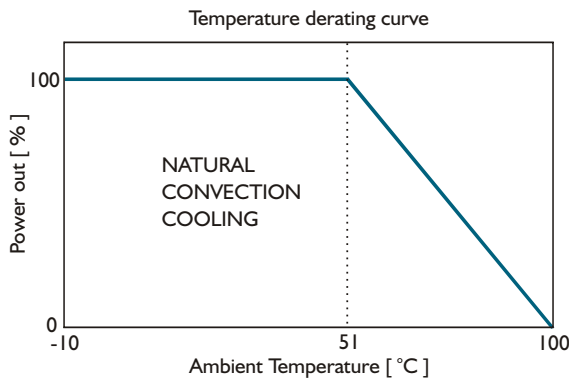

О компании

ООО "ТрейдЭлектроникс" - это оперативные поставки широкого спектра электронных компонентов отечественного и импортного производства напрямую от производителей и с крупнейших мировых складов. Реализуемая нашей компанией продукция насчитывает более полумиллиона наименований.

Благодаря этому наша компания предлагает к поставке практически не ограниченный ассортимент компонентов как оптовыми, мелкооптовыми партиями, так и в розницу.

Наличие собственной эффективной системы логистики обеспечивает надежную поставку продукции по конкурентным ценам в точно указанные сроки.

Срок поставки со стоков в **Европе и Америке – от 3 до 14 дней.**

Срок поставки из **Азии – от 10 дней.**

Благодаря развитой сети поставщиков, помогаем в поиске и приобретении экзотичных или снятых с производства компонентов.

Предоставляем спец цены на элементы для создания инженерных сэмплов.

Упорный труд, качественный результат дают нам право быть уверенными в себе и надежными для наших клиентов.

Наша компания это:

- Гарантия качества поставляемой продукции
- Широкий ассортимент
- Минимальные сроки поставок
- Техническая поддержка
- Подбор комплектации
- Индивидуальный подход
- Гибкое ценообразование

Наша организация особенно сильна в поставках модулей, микросхем, пассивных компонентов, ксайленсах (XC), EPF, EPM и силовой электроники.

Большой выбор предлагаемой продукции, различные виды оплаты и доставки, позволят Вам сэкономить время и получить максимум выгоды от сотрудничества с нами!

Перечень производителей, продукцию которых мы поставляем на российский рынок



С удовольствием будем прорабатывать для Вас поставки всех необходимых компонентов по текущим запросам для скорейшего выявления групп элементов, по которым сотрудничество именно с нашей компанией будет для Вас максимально выгодным!

С уважением,

Менеджер отдела продаж ООО

«Трейд Электроникс»

Шишлаков Евгений

8 (495)668-30-28 доб 169

manager28@tradeelectronics.ru

<http://www.tradeelectronics.ru/>