

2SA1962/FJA4213

PNP Epitaxial Silicon Transistor

Applications

- High-Fidelity Audio Output Amplifier
- General Purpose Power Amplifier

Features

- High Current Capability: $I_C = -15A$
- High Power Dissipation : 130watts
- High Frequency : 30MHz.
- High Voltage : $V_{CEO} = -230V$
- Wide S.O.A for reliable operation.
- Excellent Gain Linearity for low THD.
- Complement to 2SC5242/FJA4313.
- Thermal and electrical Spice models are available.
- Same transistor is also available in:
 - TO264 package, 2SA1943/FJL4215 : 150 watts
 - TO220 package, FJP1943 : 80 watts
 - TO220F package, FJPF1943 : 50 watts

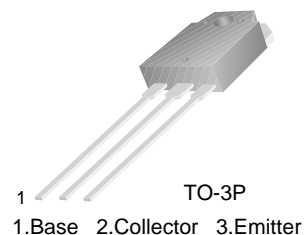

Absolute Maximum Ratings* $T_a = 25^\circ C$ unless otherwise noted

Symbol	Parameter	Ratings	Units
BV_{CBO}	Collector-Base Voltage	-230	V
BV_{CEO}	Collector-Emitter Voltage	-230	V
BV_{EBO}	Emitter-Base Voltage	-5	V
I_C	Collector Current	-15	A
I_B	Base Current	-1.5	A
P_D	Total Device Dissipation($T_C=25^\circ C$) Derate above $25^\circ C$	130 1.04	W W/ $^\circ C$
T_J, T_{STG}	Junction and Storage Temperature	- 50 ~ +150	$^\circ C$

* These ratings are limiting values above which the serviceability of any semiconductor device may be impaired.

Thermal Characteristics* $T_a=25^\circ C$ unless otherwise noted

Symbol	Parameter	Max.	Units
$R_{\theta JC}$	Thermal Resistance, Junction to Case	0.96	$^\circ C/W$

* Device mounted on minimum pad size

h_{FE} Classification

Classification	R	O
h_{FE1}	55 ~ 110	80 ~ 160

Electrical Characteristics* $T_a=25^\circ\text{C}$ unless otherwise noted

Symbol	Parameter	Test Condition	Min.	Typ.	Max.	Units
BV_{CBO}	Collector-Base Breakdown Voltage	$I_C=-5\text{mA}, I_E=0$	-230			V
BV_{CEO}	Collector-Emitter Breakdown Voltage	$I_C=-10\text{mA}, R_{BE}=\infty$	-230			V
BV_{EBO}	Emitter-Base Breakdown Voltage	$I_E=-5\text{mA}, I_C=0$	-5			V
I_{CBO}	Collector Cut-off Current	$V_{CB}=-230\text{V}, I_E=0$			-5.0	μA
I_{EBO}	Emitter Cut-off Current	$V_{EB}=-5\text{V}, I_C=0$			-5.0	μA
h_{FE1}	DC Current Gain	$V_{CE}=-5\text{V}, I_C=-1\text{A}$	55		160	
h_{FE2}	DC Current Gain	$V_{CE}=-5\text{V}, I_C=-7\text{A}$	35	60		
$V_{CE}(\text{sat})$	Collector-Emitter Saturation Voltage	$I_C=-8\text{A}, I_B=-0.8\text{A}$		-0.4	-3.0	V
$V_{BE}(\text{on})$	Base-Emitter On Voltage	$V_{CE}=-5\text{V}, I_C=-7\text{A}$		-1.0	-1.5	V
f_T	Current Gain Bandwidth Product	$V_{CE}=-5\text{V}, I_C=-1\text{A}$		30		MHz
C_{ob}	Output Capacitance	$V_{CB}=-10\text{V}, f=1\text{MHz}$		360		pF

* Pulse Test: Pulse Width=20 μs , Duty Cycle \leq 2%**Ordering Information**

Part Number	Marking	Package	Packing Method	Remarks
2SA1962RTU	A1962R	TO-3P	TUBE	hFE1 R grade
2SA1962OTU	A1962O	TO-3P	TUBE	hFE1 O grade
FJA4213RTU	J4213R	TO-3P	TUBE	hFE1 R grade
FJA4213OTU	J4213O	TO-3P	TUBE	hFE1 O grade

Typical Characteristics

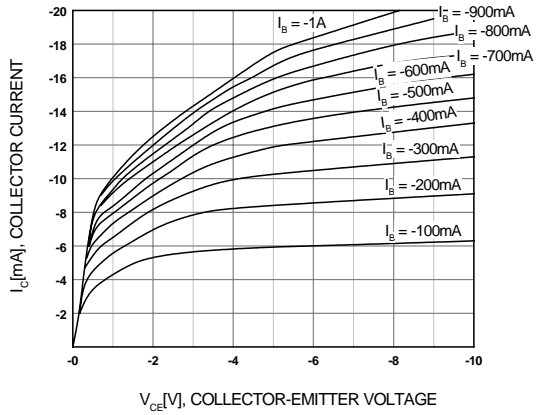

Figure 1. Static Characteristic

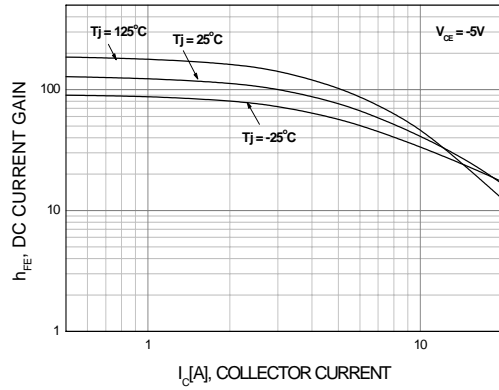

Figure 2. DC current Gain

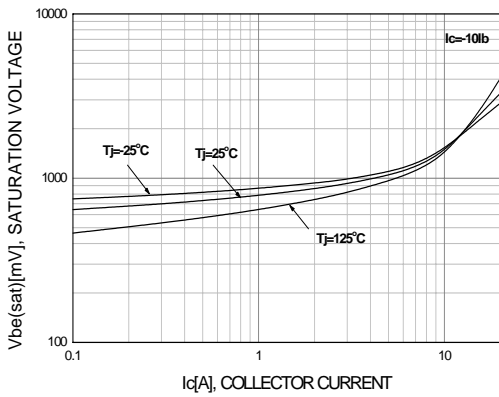

Figure 3. Base-Emitter Saturation Voltage

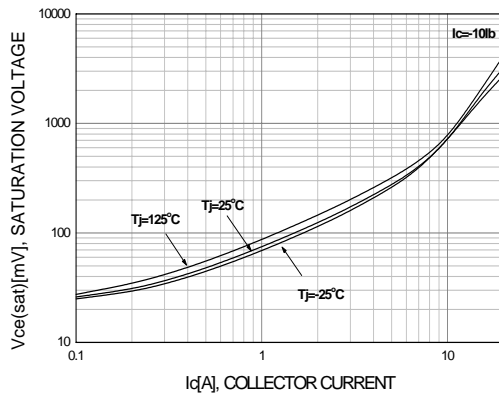

Figure 4. Collector-Emitter Saturation Voltage

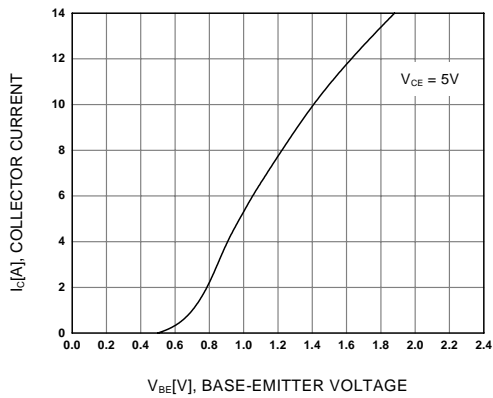

Figure 5. Base-Emitter On Voltage

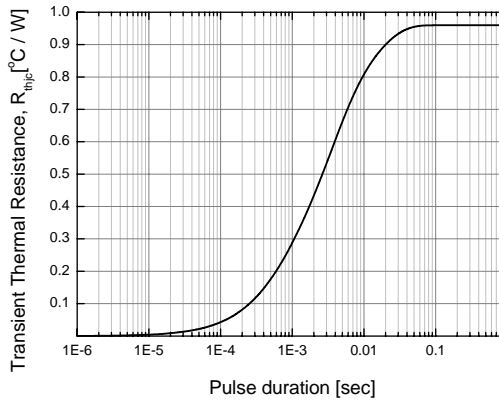

Figure 6. Thermal Resistance

Typical Characteristics

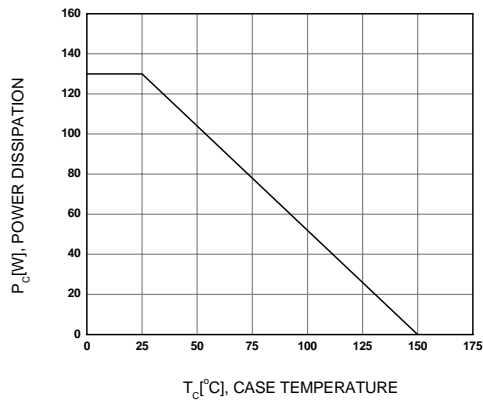

Figure 7. Power Derating

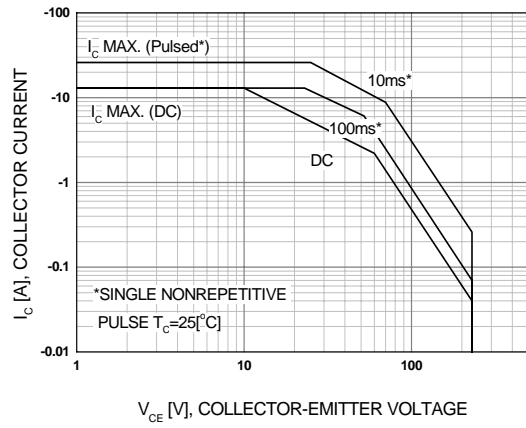
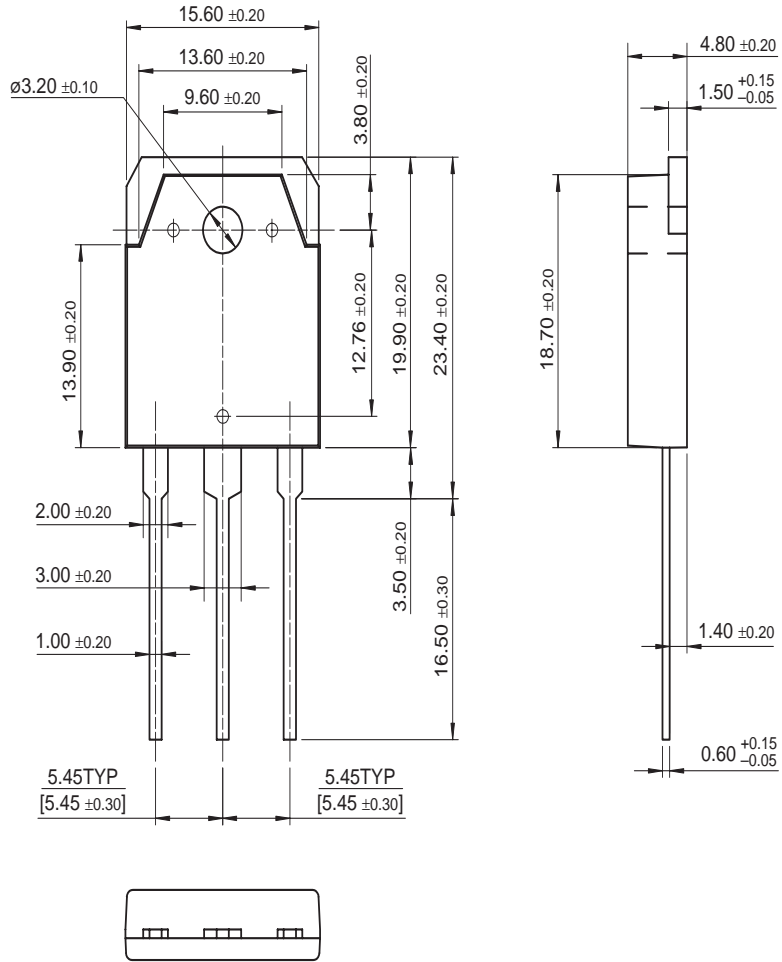

Figure 8. Safe Operating Area

Package Dimensions

TO-3P



Dimensions in Millimeters



TRADEMARKS

The following are registered and unregistered trademarks and service marks Fairchild Semiconductor owns or is authorized to use and is not intended to be an exhaustive list of all such trademarks.

- | | | | |
|---|---|----------------------------|---|
| ACEx® | Green FPS™ | Power247® | SuperSOT™-8 |
| Build it Now™ | Green FPS™ e-Series™ | POWEREDGE® | SyncFET™ |
| CorePLUS™ | GTO™ | Power-SPM™ | The Power Franchise® |
| CROSSVOLT™ | i-Lo™ | PowerTrench® |  |
| CTL™ | IntelliMAX™ | Programmable Active Droop™ | TinyBoost™ |
| Current Transfer Logic™ | ISOPLANAR™ | QFET® | TinyBuck™ |
| EcoSPARK® | MegaBuck™ | QS™ | TinyLogic® |
|  | MICROCOUPLER™ | QT Optoelectronics™ | TinyOPTO™ |
| Fairchild® | MicroFET™ | Quiet Series™ | TinyPower™ |
| Fairchild Semiconductor® | MicroPak™ | RapidConfigure™ | TinyPWM™ |
| FACT Quiet Series™ | MillerDrive™ | SMART START™ | TinyWire™ |
| FACT® | Motion-SPM™ | SPM® | μSerDes™ |
| FAST® | OPTOLOGIC® | STEALTH™ | UHC® |
| FastvCore™ | OPTOPLANAR® | SuperFET™ | UniFET™ |
| FPST™ |  | SuperSOT™-3 | VCX™ |
| FRFET® | PDP-SPM™ | SuperSOT™-6 | |
| Global Power Resource SM | Power220® | | |

DISCLAIMER

FAIRCHILD SEMICONDUCTOR RESERVES THE RIGHT TO MAKE CHANGES WITHOUT FURTHER NOTICE TO ANY PRODUCTS HEREIN TO IMPROVE RELIABILITY, FUNCTION, OR DESIGN. FAIRCHILD DOES NOT ASSUME ANY LIABILITY ARISING OUT OF THE APPLICATION OR USE OF ANY PRODUCT OR CIRCUIT DESCRIBED HEREIN; NEITHER DOES IT CONVEY ANY LICENSE UNDER ITS PATENT RIGHTS, NOR THE RIGHTS OF OTHERS. THESE SPECIFICATIONS DO NOT EXPAND THE TERMS OF FAIRCHILD'S WORLDWIDE TERMS AND CONDITIONS, SPECIFICALLY THE WARRANTY THEREIN, WHICH COVERS THESE PRODUCTS.

LIFE SUPPORT POLICY

FAIRCHILD'S PRODUCTS ARE NOT AUTHORIZED FOR USE AS CRITICAL COMPONENTS IN LIFE SUPPORT DEVICES OR SYSTEMS WITHOUT THE EXPRESS WRITTEN APPROVAL OF FAIRCHILD SEMICONDUCTOR CORPORATION.

As used herein:

1. Life support devices or systems are devices or systems which, (a) are intended for surgical implant into the body, or (b) support or sustain life, and (c) whose failure to perform when properly used in accordance with instructions for use provided in the labeling, can be reasonably expected to result in significant injury to the user.
2. A critical component is any component of a life support device or system whose failure to perform can be reasonably expected to cause the failure of the life support device or system, or to affect its safety or effectiveness.

PRODUCT STATUS DEFINITIONS

Definition of Terms

Datasheet Identification	Product Status	Definition
Advance Information	Formative or In Design	This datasheet contains the design specifications for product development. Specifications may change in any manner without notice.
Preliminary	First Production	This datasheet contains preliminary data; supplementary data will be published at a later date. Fairchild Semiconductor reserves the right to make changes at any time without notice to improve design.
No Identification Needed	Full Production	This datasheet contains final specifications. Fairchild Semiconductor reserves the right to make changes at any time without notice to improve design.
Obsolete	Not In Production	This datasheet contains specifications on a product that has been discontinued by Fairchild semiconductor. The datasheet is printed for reference information only.

О компании

ООО "ТрейдЭлектроникс" - это оперативные поставки широкого спектра электронных компонентов отечественного и импортного производства напрямую от производителей и с крупнейших мировых складов. Реализуемая нашей компанией продукция насчитывает более полумиллиона наименований.

Благодаря этому наша компания предлагает к поставке практически не ограниченный ассортимент компонентов как оптовыми, мелкооптовыми партиями, так и в розницу.

Наличие собственной эффективной системы логистики обеспечивает надежную поставку продукции по конкурентным ценам в точно указанные сроки.

Срок поставки со стоков в **Европе и Америке – от 3 до 14 дней.**

Срок поставки из **Азии – от 10 дней.**

Благодаря развитой сети поставщиков, помогаем в поиске и приобретении экзотичных или снятых с производства компонентов.

Предоставляем спец цены на элементы для создания инженерных сэмплов.

Упорный труд, качественный результат дают нам право быть уверенными в себе и надежными для наших клиентов.

Наша компания это:

- Гарантия качества поставляемой продукции
- Широкий ассортимент
- Минимальные сроки поставок
- Техническая поддержка
- Подбор комплектации
- Индивидуальный подход
- Гибкое ценообразование

Наша организация особенно сильна в поставках модулей, микросхем, пассивных компонентов, ксайленсах (XC), EPF, EPM и силовой электроники.

Большой выбор предлагаемой продукции, различные виды оплаты и доставки, позволят Вам сэкономить время и получить максимум выгоды от сотрудничества с нами!

Перечень производителей, продукцию которых мы поставляем на российский рынок



С удовольствием будем прорабатывать для Вас поставки всех необходимых компонентов по текущим запросам для скорейшего выявления групп элементов, по которым сотрудничество именно с нашей компанией будет для Вас максимально выгодным!

С уважением,

Менеджер отдела продаж ООО

«Трейд Электроникс»

Шишлаков Евгений

8 (495)668-30-28 доб 169

manager28@tradeelectronics.ru

<http://www.tradeelectronics.ru/>