

FDD603AL

N-Channel Logic Level Enhancement Mode Field Effect Transistor

General Description

This N-Channel logic level enhancement mode power field effect transistor is produced using Fairchild's proprietary, high cell density, DMOS technology. This very high density process is tailored to minimize on-state resistance. These devices are particularly suited for low voltage applications such as DC/DC converters and high efficiency switching circuits where fast switching, low in-line power loss, and resistance to transients are needed.

Applications

- DC/DC converters
- Motor drives

Features

- 33 A, 30 V. $R_{DS(ON)} = 0.023 \Omega @ V_{GS} = 10 \text{ V}$
 $R_{DS(ON)} = 0.037 \Omega @ V_{GS} = 4.5 \text{ V}$.
- Critical DC electrical parameters specified at elevated temperature.
- Rugged avalanche-rated internal source-drain diode can eliminate the need for external Zener Diode.
- High density cell design for extremely low $R_{DS(ON)}$.

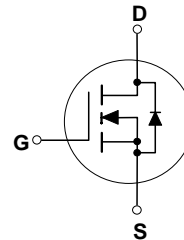
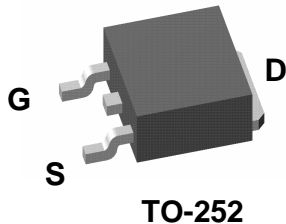

Absolute Maximum Ratings T_c=25°C unless otherwise noted

Symbol	Parameter	Rated	Units		
V _{DSS}	Drain-Source Voltage	30	V		
V _{GSS}	Gate-Source Voltage	±20	V		
I _D	Maximum Drain Current - Continuous <small>(Note 1)</small> $T_A = 25^\circ\text{C}$ <small>(Note 1a)</small>	33	A		
	Maximum Drain Current - Pulsed	80			
P _D	Maximum Power Dissipation @ $T_C = 25^\circ\text{C}$ <small>(Note 1)</small> $T_A = 25^\circ\text{C}$ <small>(Note 1a)</small> $T_A = 25^\circ\text{C}$ <small>(Note 1b)</small>	39 3.2 1.3	W		
	T _J , T _{stg}	Operating and Storage Junction Temperature Range		-55 to +150	°C

Thermal Characteristics

R _{θJC}	Thermal Resistance, Junction-to-Case <small>(Note 1)</small>	2.5	°C/W
R _{θJA}	Thermal Resistance, Junction-to-Ambient <small>(Note 1a)</small>	40	°C/W
		96	°C/W

Package Marking and Ordering Information

Device Marking	Device	Reel Size	Tape Width	Quantity
FDD603AL	FDD603AL	13"	16mm	2500

Electrical Characteristics

$T_A = 25^\circ\text{C}$ unless otherwise noted

Symbol	Parameter	Test Conditions	Min	Typ	Max	Units
Off Characteristics						
W_{DSS}	Single Pulse Drain-Source Avalanche Energy	$V_{DD} = 15\text{ V}, I_D = 12\text{ A}$			100	mJ
I_{AR}	Maximum Drain-Source Avalanche Current				12	A
BV_{DSS}	Drain-Source Breakdown Voltage	$V_{GS} = 0\text{ V}, I_D = 250\ \mu\text{A}$	30			V
$\frac{\Delta BV_{DSS}}{\Delta T_J}$	Breakdown Voltage Temperature Coefficient	$I_D = 250\ \mu\text{A}$, Referenced to 25°C		32		mV/ $^\circ\text{C}$
I_{DSS}	Zero Gate Voltage Drain Current	$V_{DS} = 24\text{ V}, V_{GS} = 0\text{ V}$			10	μA
I_{GSSF}	Gate-Body Leakage Current, Forward	$V_{GS} = 20\text{ V}, V_{DS} = 0\text{ V}$			100	nA
I_{GSSR}	Gate-Body Leakage Current, Reverse	$V_{GS} = -20\text{ V}, V_{DS} = 0\text{ V}$			-100	nA

On Characteristics (Note 2)

$V_{GS(th)}$	Gate Threshold Voltage	$V_{DS} = V_{GS}, I_D = 250\ \mu\text{A}$	1	1.7	3	V
$\frac{\Delta V_{GS(th)}}{\Delta T_J}$	Gate Threshold Voltage Temperature Coefficient	$I_D = 250\ \mu\text{A}$, Referenced to 25°C		-4.5		mV/ $^\circ\text{C}$
$R_{DS(on)}$	Static Drain-Source On-Resistance	$V_{GS} = 10\text{ V}, I_D = 9.5\text{ A}$ $V_{GS} = 10\text{ V}, I_D = 9.5\text{ A}, T_J = 125^\circ\text{C}$ $V_{GS} = 4.5\text{ V}, I_D = 7.5\text{ A}$		0.016 0.024 0.026	0.023 0.035 0.037	Ω
$I_{D(on)}$	On-State Drain Current	$V_{GS} = 10\text{ V}, V_{DS} = 10\text{ V}$	60			A
g_{FS}	Forward Transconductance	$V_{DS} = 10\text{ V}, I_D = 9.5\text{ A}$		18		S

Dynamic Characteristics

C_{iss}	Input Capacitance	$V_{DS} = 15\text{ V}, V_{GS} = 0\text{ V}$ $f = 1.0\text{ MHz}$		670		pF
C_{oss}	Output Capacitance			345		pF
C_{riss}	Reverse Transfer Capacitance			95		pF

Switching Characteristics (Note 2)

$t_{d(on)}$	Turn-On Delay Time	$V_{DD} = 15\text{ V}, I_D = 1\text{ A}$ $V_{GS} = 10\text{ V}, R_{GEN} = 6\ \Omega$		10	20	ns
t_r	Turn-On Rise Time			16	30	ns
$t_{d(off)}$	Turn-Off Delay Time			27	45	ns
t_f	Turn-Off Fall Time			12	22	ns
Q_g	Total Gate Charge	$V_{DS} = 10\text{ V}, I_D = 9.5\text{ A}$ $V_{GS} = 10\text{ V}$		19	26	nC
Q_{gs}	Gate-Source Charge			3.5		nC
Q_{gd}	Gate-Drain Charge			5.5		nC

Drain-Source Diode Characteristics and Maximum Ratings

I_S	Maximum Continuous Drain-Source Diode Forward Current <small>(Note 1)</small>			33		A
V_{SD}	Drain-Source Diode Forward Voltage	$V_{GS} = 0\text{ V}, I_S = 2.3\text{ A}$ <small>(Note 2)</small>		0.78	1.2	V

Notes:

- $R_{\theta JA}$ is the sum of the junction-to-case and case-to-ambient thermal resistance where the case thermal reference is defined as the drain tab. $R_{\theta JC}$ is guaranteed by design while $R_{\theta CA}$ is determined by the user's board design. $R_{\theta JC}$ has been used to determine some maximum ratings.



Scale 1 : 1 on letter size paper

■ a) $R_{\theta JA} = 40^\circ\text{C/W}$ when mounted on a 1 in^2 pad of 2oz copper.

■ b) $R_{\theta JA} = 96^\circ\text{C/W}$ on a minimum mounting pad.

- Pulse Test: Pulse Width $\leq 300\ \mu\text{s}$, Duty Cycle $\leq 2.0\%$

Typical Characteristics

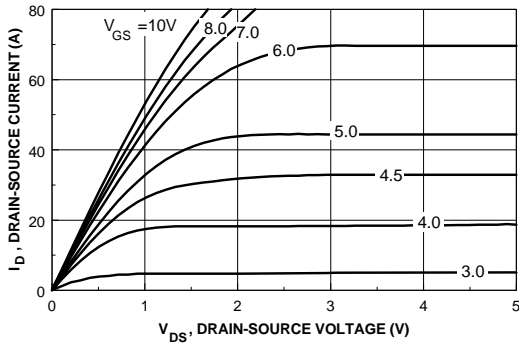

Figure 1. On-Region Characteristics.

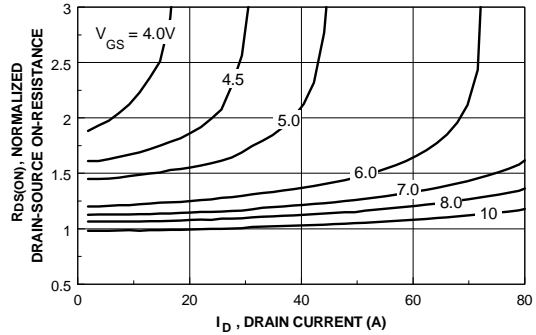

Figure 2. On-Resistance Variation with Drain Current and Gate Voltage.

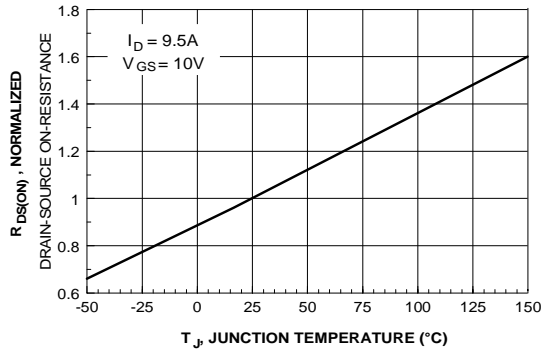

Figure 3. On-Resistance Variation with Temperature.

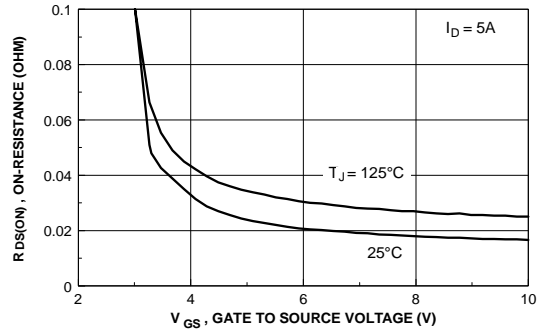

Figure 4. On-Resistance Variation with Gate-to-Source Voltage.

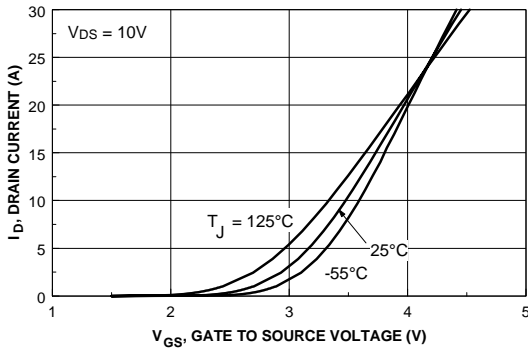

Figure 5. Transfer Characteristics.

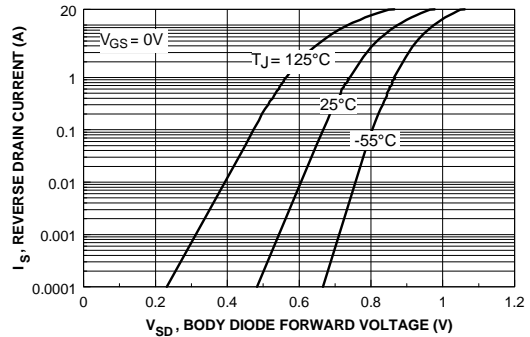

Figure 6. Body Diode Forward Voltage Variation with Source Current and Temperature.

Typical Characteristics (continued)

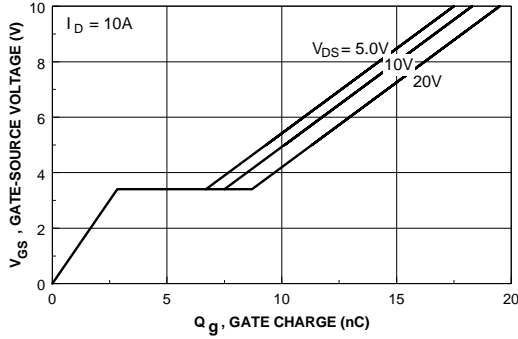

Figure 7. Gate-Charge Characteristics.

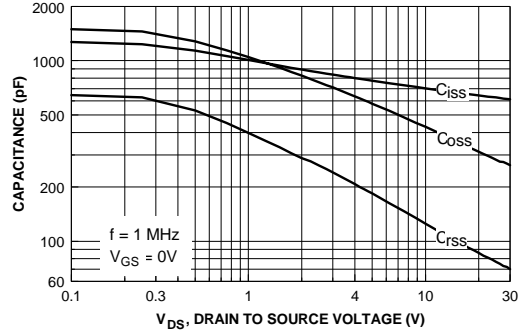

Figure 8. Capacitance Characteristics.

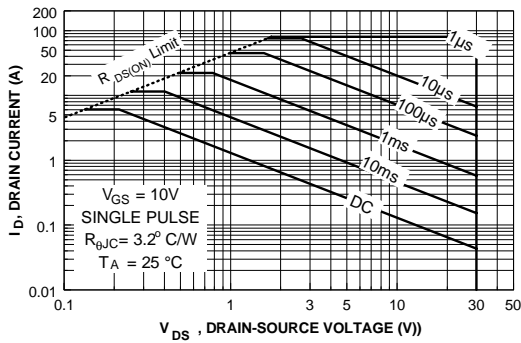

Figure 9. Maximum Safe Operating Area.

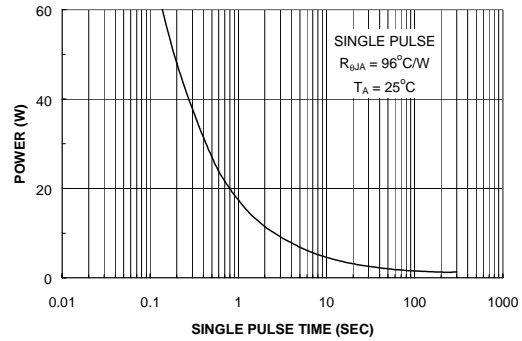

Figure 10. Single Pulse Maximum Power Dissipation.

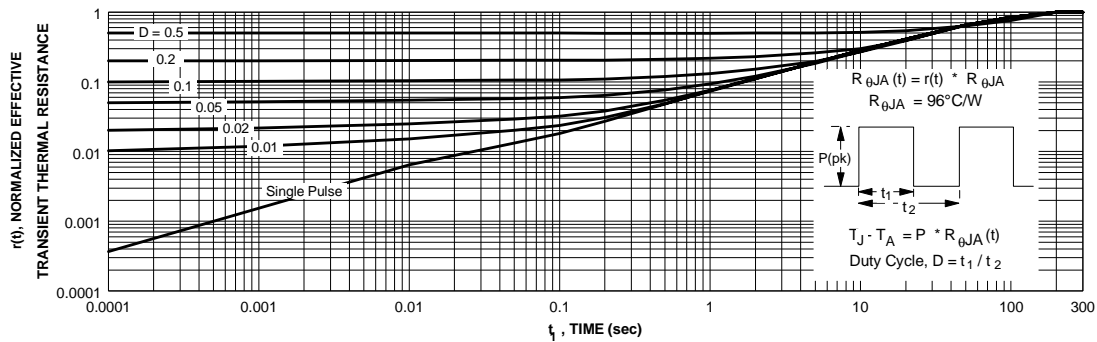

Figure 11. Transient Thermal Response Curve.

Thermal characterization performed using the conditions described in Note 1b. Transient thermal response will change depending on the circuit board design.

TO-252 Tape and Reel Data and Package Dimensions



D-PAK (TO-252) Packaging Configuration: Figure 1.0

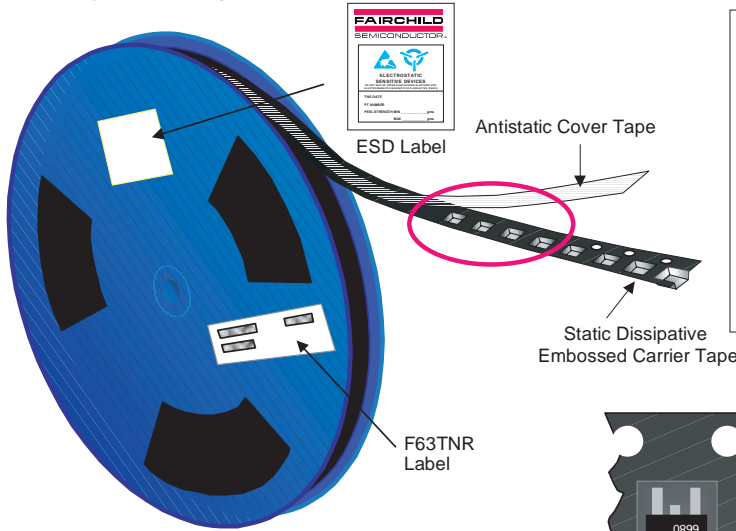

Packaging Description:

TO-252 parts are shipped in tape. The carrier tape is made from a dissipative (carbon filled) polycarbonate resin. The cover tape is a multilayer film (Heat Activated Adhesive in nature) primarily composed of polyester film, adhesive layer, sealant, and anti-static sprayed agent. These reeled parts in standard option are shipped with 2500 units per 13" or 330mm diameter reel. The reels are dark blue in color and is made of polystyrene plastic (anti-static coated). This and some other options are further described in the Packaging Information table.

These full reels are individually barcode labeled and placed inside a standard intermediate box (illustrated in figure 1.0) made of recyclable corrugated brown paper. One box contains two reels maximum. And these boxes are placed inside a barcode labeled shipping box which comes in different sizes depending on the number of parts shipped.

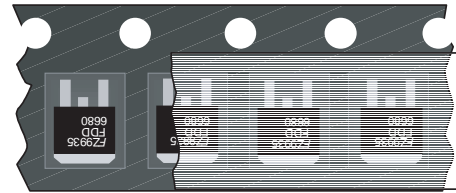

D-PAK (TO-252) Unit Orientation

D-PAK (TO-252) Packaging Information	
Packaging Option	Standard (no flow code)
Packaging type	TNR
Qty per Reel/Tube/Bag	2,500
Reel Size	13" Dia
Box Dimension (mm)	359x359x57
Max qty per Box	5,000
Weight per unit (gm)	0.300
Weight per Reel(kg)	1.200
Note/Comments	

359mm x 359mm x 57mm
Standard Intermediate box

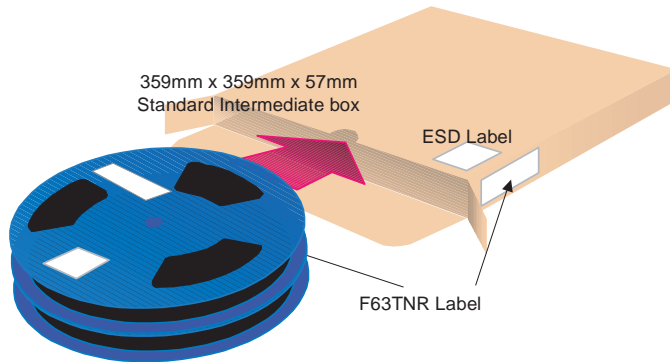

F63TNR Label sample

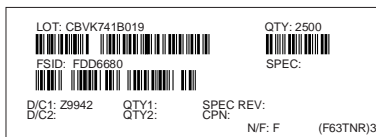

TO-252 (D-PAK) Tape Leader and Trailer Configuration: Figure 2.0

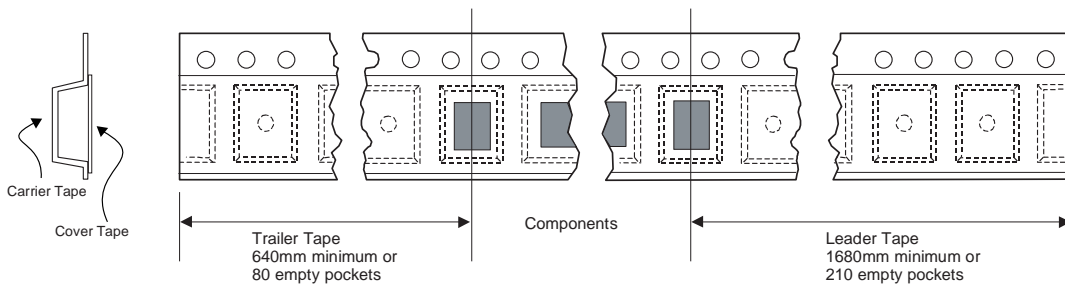

TO-252 Tape and Reel Data and Package Dimensions

D-PAK (TO-252) Embossed Carrier Tape Configuration: Figure 3.0

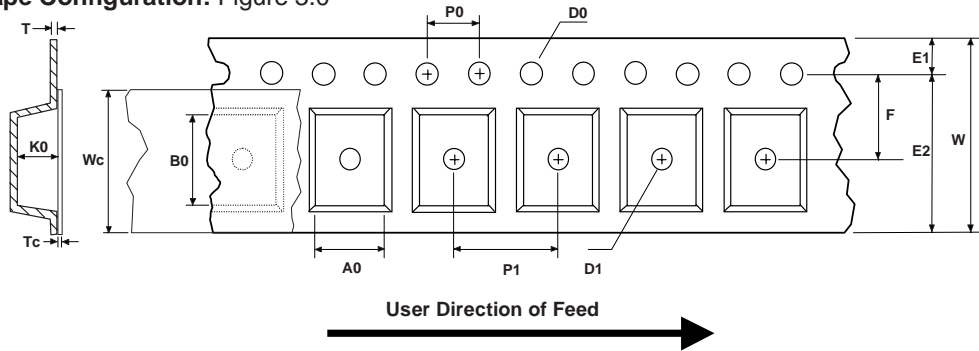

Dimensions are in millimeter														
Pkg type	A0	B0	W	D0	D1	E1	E2	F	P1	P0	K0	T	Wc	Tc
TO252 (24mm)	6.90 +/-0.10	10.50 +/-0.10	16.0 +/-0.3	1.55 +/-0.05	1.5 +/-0.10	1.75 +/-0.10	14.25 min	7.50 +/-0.10	8.0 +/-0.1	4.0 +/-0.1	2.65 +/-0.10	0.30 +/-0.05	13.0 +/-0.3	0.06 +/-0.02

Notes: A0, B0, and K0 dimensions are determined with respect to the EIA/Jedec RS-481 rotational and lateral movement requirements (see sketches A, B, and C).

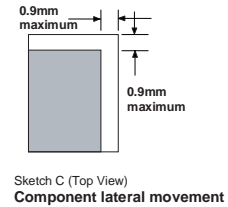
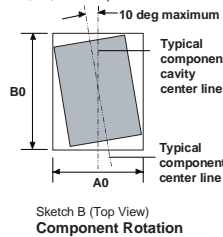
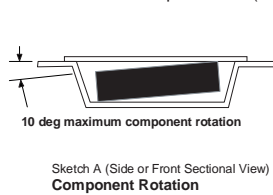

D-PAK (TO-252) Reel Configuration: Figure 4.0

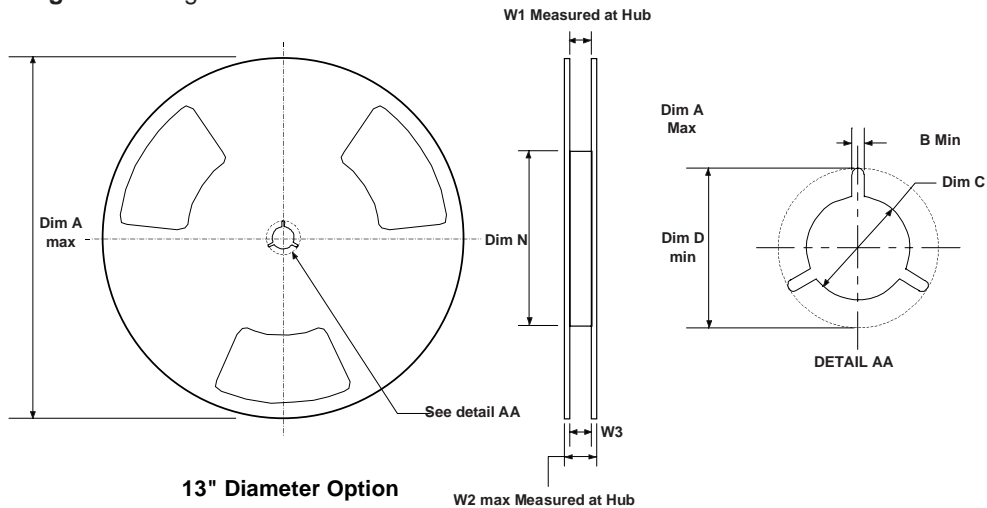

Dimensions are in inches and millimeters									
Tape Size	Reel Option	Dim A	Dim B	Dim C	Dim D	Dim N	Dim W1	Dim W2	Dim W3 (LSL-USL)
164mm	13" Dia	13.00 330	0.059 1.5	512 +0.020/-0.008 13 +0.5/-0.2	0.795 20.2	4.00 100	0.646 +0.078/-0.000 16.4 +2/0	0.882 22.4	0.626 - 0.764 15.9 - 19.4

TRADEMARKS

The following are registered and unregistered trademarks Fairchild Semiconductor owns or is authorized to use and is not intended to be an exhaustive list of all such trademarks.

ACEx™	ISOPANAR™	TinyLogic™
CoolFET™	MICROWIRE™	UHC™
CROSSVOLT™	POP™	VCX™
E ² CMOS™	PowerTrench®	
FACT™	QFET™	
FACT Quiet Series™	QS™	
FAST®	Quiet Series™	
FASTr™	SuperSOT™-3	
GTO™	SuperSOT™-6	
HiSeC™	SuperSOT™-8	

DISCLAIMER

FAIRCHILD SEMICONDUCTOR RESERVES THE RIGHT TO MAKE CHANGES WITHOUT FURTHER NOTICE TO ANY PRODUCTS HEREIN TO IMPROVE RELIABILITY, FUNCTION OR DESIGN. FAIRCHILD DOES NOT ASSUME ANY LIABILITY ARISING OUT OF THE APPLICATION OR USE OF ANY PRODUCT OR CIRCUIT DESCRIBED HEREIN; NEITHER DOES IT CONVEY ANY LICENSE UNDER ITS PATENT RIGHTS, NOR THE RIGHTS OF OTHERS.

LIFE SUPPORT POLICY

FAIRCHILD'S PRODUCTS ARE NOT AUTHORIZED FOR USE AS CRITICAL COMPONENTS IN LIFE SUPPORT DEVICES OR SYSTEMS WITHOUT THE EXPRESS WRITTEN APPROVAL OF FAIRCHILD SEMICONDUCTOR CORPORATION. As used herein:

1. Life support devices or systems are devices or systems which, (a) are intended for surgical implant into the body, or (b) support or sustain life, or (c) whose failure to perform when properly used in accordance with instructions for use provided in the labeling, can be reasonably expected to result in significant injury to the user.
2. A critical component is any component of a life support device or system whose failure to perform can be reasonably expected to cause the failure of the life support device or system, or to affect its safety or effectiveness.

PRODUCT STATUS DEFINITIONS

Definition of Terms

Datasheet Identification	Product Status	Definition
Advance Information	Formative or In Design	This datasheet contains the design specifications for product development. Specifications may change in any manner without notice.
Preliminary	First Production	This datasheet contains preliminary data, and supplementary data will be published at a later date. Fairchild Semiconductor reserves the right to make changes at any time without notice in order to improve design.
No Identification Needed	Full Production	This datasheet contains final specifications. Fairchild Semiconductor reserves the right to make changes at any time without notice in order to improve design.
Obsolete	Not In Production	This datasheet contains specifications on a product that has been discontinued by Fairchild semiconductor. The datasheet is printed for reference information only.

О компании

ООО "ТрейдЭлектроникс" - это оперативные поставки широкого спектра электронных компонентов отечественного и импортного производства напрямую от производителей и с крупнейших мировых складов. Реализуемая нашей компанией продукция насчитывает более полумиллиона наименований.

Благодаря этому наша компания предлагает к поставке практически не ограниченный ассортимент компонентов как оптовыми, мелкооптовыми партиями, так и в розницу.

Наличие собственной эффективной системы логистики обеспечивает надежную поставку продукции по конкурентным ценам в точно указанные сроки.

Срок поставки со стоков в **Европе и Америке – от 3 до 14 дней.**

Срок поставки из **Азии – от 10 дней.**

Благодаря развитой сети поставщиков, помогаем в поиске и приобретении экзотичных или снятых с производства компонентов.

Предоставляем спец цены на элементы для создания инженерных сэмплов.

Упорный труд, качественный результат дают нам право быть уверенными в себе и надежными для наших клиентов.

Наша компания это:

- Гарантия качества поставляемой продукции
- Широкий ассортимент
- Минимальные сроки поставок
- Техническая поддержка
- Подбор комплектации
- Индивидуальный подход
- Гибкое ценообразование

Наша организация особенно сильна в поставках модулей, микросхем, пассивных компонентов, ксайленсах (XC), EPF, EPM и силовой электроники.

Большой выбор предлагаемой продукции, различные виды оплаты и доставки, позволят Вам сэкономить время и получить максимум выгоды от сотрудничества с нами!

Перечень производителей, продукцию которых мы поставляем на российский рынок

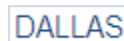

С удовольствием будем прорабатывать для Вас поставки всех необходимых компонентов по текущим запросам для скорейшего выявления групп элементов, по которым сотрудничество именно с нашей компанией будет для Вас максимально выгодным!

С уважением,

Менеджер отдела продаж ООО

«Трейд Электроникс»

Шишлаков Евгений

8 (495)668-30-28 доб 169

manager28@tradeelectronics.ru

<http://www.tradeelectronics.ru/>